

Serie UP

UP200-6

USO GENERAL AGM

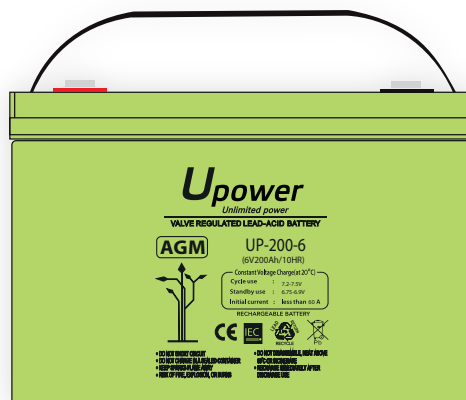

Características Principales

- Máxima calidad y fiabilidad**

Exhaustivos procesos de control, desde la materia prima a la entrega del producto al cliente final, dentro de los estándares internacionales de calidad implementados en la compañía.

- Válvulas de regulación de gases**

Diseñadas para una mejor recombinación de los gases con la mínima pérdida de hidrógeno, ayudan a la regulación interna de la presión, incrementando el rendimiento y la seguridad.

Especificaciones Técnicas

Voltaje Nominal (V)	6
Capacidad Nominal (10 Hr)	200.0 Ah
Dimensiones	Longitud: 306 ± 3mm (12.05 pulgadas)
	Anchura: 168 ± 2mm (6.61 pulgadas)
	Altura: 222 ± 3mm (8.74 pulgadas)
	Altura Total (+terminal): 228 ± 3mm (8.98 pulgadas)
Peso Aproximado	29.0 kg (63.9 libras)
Terminal	T8
Material del Contenedor	ABS
Capacidad Clasificada	208.0 Ah / 10.4 A (20hr, 1.80V/celda, 25°C/77°F)
	200.0 Ah / 20.0 A (10hr, 1.80V/celda, 25°C/77°F)
	172.0 Ah / 34.4 A (5hr, 1.75V/celda, 25°C/77°F)
	156.0 Ah / 52.0 A (3hr, 1.75V/celda, 25°C/77°F)
	122.0 Ah / 122.0 A (1hr, 1.60V/celda, 25°C/77°F)
Corriente Máxima de Descarga	2000 A (5s)
Resistencia Interna	Aprox. 1.4 mΩ
Rango de Temperatura de Funcionamiento	Descarga: -15 ~ 50°C (5 ~ 122°F)
	Carga: 0 ~ 40°C (32 ~ 104°F)
	Almacenamiento: -15 ~ 40°C (5 ~ 104°F)
Rango de Temperatura Nominal de Funcionamiento	25 ± 3°C (77 ± 5°F)
Uso del Ciclo	Corriente de Carga Inicial inferior a 60 A de voltaje. 7.2~7.5V a 25°C (77°F) Temp. Coeficiente -15mV/°C
Uso en Espera	Sin límite en el Voltaje de Corriente de Carga Inicial. 6.75~6.9V a 25°C (77°F) Temp. Coeficiente -10mV/°C
Capacidad Afectada por Temperatura	40°C (104°F) 103%
	25°C (77°F) 100%
	0°C (32°F) 86%
Autodescarga	Las baterías pueden almacenarse hasta 6 meses a 25°C (77°F) y luego se requiere una carga de refresco.



Dimensiones de la Batería

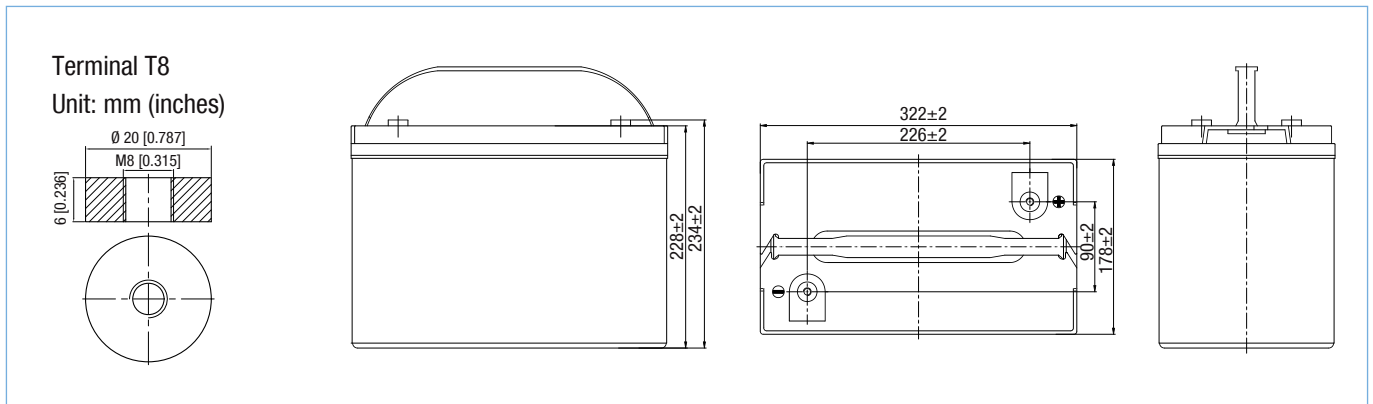

Tablas de Descarga de la Batería

Descarga de Corriente Constante (Amperios) a 25°C (77°F)

F.V/Tiempo	5min	10min	15min	20min	30min	45min	1h	2h	3h	4h	5h	6h	8h	10h	20h
1.85V/celda	342.3	269.1	228.9	191.4	152.1	115.1	94.3	60.1	47.5	38.8	31.3	27.2	22.1	18.9	10.3
1.80V/celda	459.5	343.9	276.5	226.3	179.5	133.9	105.6	65.5	51.1	41.4	33.6	29.2	23.4	20.0	10.4
1.75V/celda	/	377.8	302.0	243.4	186.4	139.0	110.5	68.0	52.0	42.3	34.4	30.0	23.8	20.2	10.5
1.70V/celda	/	411.8	322.5	255.8	194.0	144.5	114.0	70.7	53.5	43.5	35.3	30.6	24.2	20.4	10.7
1.65V/celda	/	444.4	342.9	271.8	204.6	148.1	117.8	72.7	55.8	45.0	36.3	31.3	24.6	20.8	10.8
1.60V/celda	/	/	366.7	289.5	216.0	154.4	122.0	75.1	57.5	46.4	37.5	32.0	24.8	21.0	10.9

Descarga de Potencia Constante (Vatios) a 25°C (77°F)

F.V/Tiempo	5min	10min	15min	20min	30min	45min	1h	2h	3h	4h	5h	6h	8h	10h	20h
1.85V/celda	625.9	497.1	427.1	360.8	290.0	221.3	181.9	116.6	92.6	75.8	61.3	53.5	43.6	37.4	20.4
1.80V/celda	831.2	627.7	509.0	420.3	336.9	255.4	202.6	126.4	99.0	80.5	65.5	57.2	46.1	39.5	20.6
1.75V/celda	/	678.7	549.2	447.8	346.9	262.5	211.0	130.6	100.5	82.1	67.0	58.6	46.8	39.9	20.7
1.70V/celda	/	723.0	578.2	467.1	359.1	272.0	217.0	135.6	103.1	84.1	68.6	59.7	47.4	40.2	21.1
1.65V/celda	/	773.1	610.1	492.5	375.7	276.3	222.7	138.5	107.0	86.6	70.2	60.8	48.1	41.0	21.4
1.60V/celda	/	/	641.7	518.9	393.8	286.4	229.4	142.5	109.8	89.1	72.3	62.0	48.4	41.4	21.5

Características de la Descarga

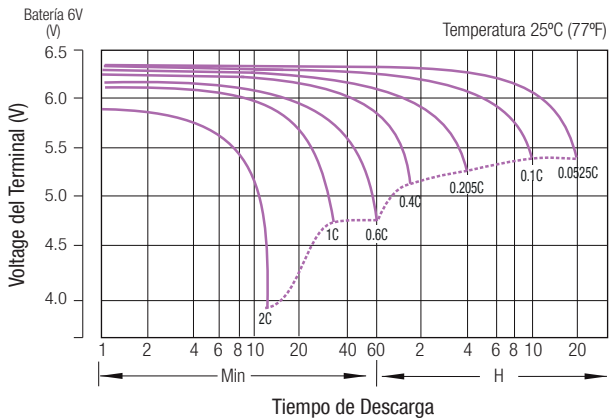

Efecto de la Temperatura sobre la Vida Útil Flotante a Largo Plazo

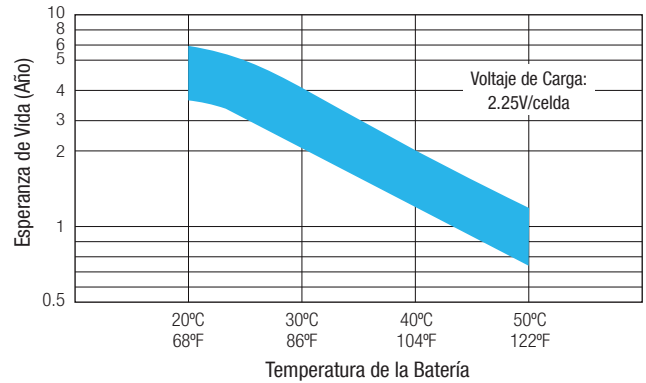

Características de Carga Flotante

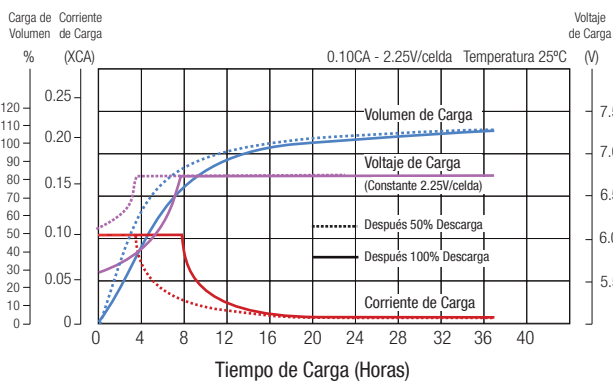

Ciclo de Vida en relación con la Profundidad de Descarga

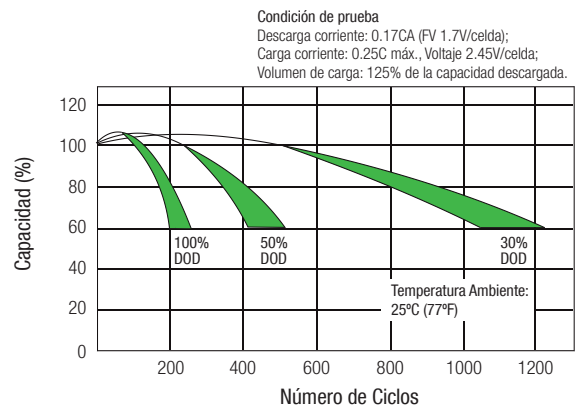

Efectos de la Temperatura en relación con la Capacidad de la Batería

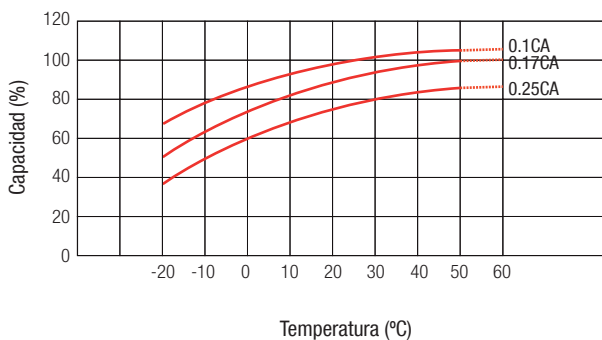

Características de Autodescarga

