

# Serie UP

# UP150-6

USO GENERAL AGM

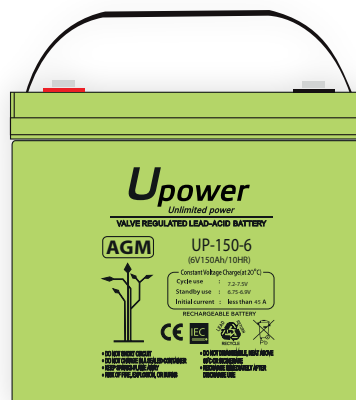

## Características Principales

- Máxima calidad y fiabilidad**

Exhaustivos procesos de control, desde la materia prima a la entrega del producto al cliente final, dentro de los estándares internacionales de calidad implementados en la compañía.

- Válvulas de regulación de gases**

Diseñadas para una mejor recombinación de los gases con la mínima pérdida de hidrógeno, ayudan a la regulación interna de la presión, incrementando el rendimiento y la seguridad.

## Especificaciones Técnicas

Voltaje Nominal (V)	6
Capacidad Nominal (10 Hr)	150.0 Ah
Dimensiones	Longitud: 260 ± 3mm (10.2 pulgadas)
	Anchura: 180 ± 2mm (7.09 pulgadas)
	Altura: 247 ± 3mm (9.72 pulgadas)
	Altura Total (+terminal): 253 ± 3mm (9.96 pulgadas)
Peso Aproximado	21.2 kg (46.7 libras)
Terminal	T6
Material del Contenedor	ABS
Capacidad Clasificada	156.0 Ah / 7.80 A (20hr, 1.80V/celda, 25°C/77°F)
	150.0 Ah / 15.0 A (10hr, 1.80V/celda, 25°C/77°F)
	129.0 Ah / 25.8 A (5hr, 1.75V/celda, 25°C/77°F)
	117.0 Ah / 39.0 A (3hr, 1.75V/celda, 25°C/77°F)
	91.5 Ah / 91.5 A (1hr, 1.60V/celda, 25°C/77°F)
Corriente Máxima de Descarga	1500 A (5s)
Resistencia Interna	Aprox. 3.0 mΩ
Rango de Temperatura de Funcionamiento	Descarga: -15 ~ 50°C (5 ~ 122°F)
	Carga: 0 ~ 40°C (32 ~ 104°F)
	Almacenamiento: -15 ~ 40°C (5 ~ 104°F)
Rango de Temperatura Nominal de Funcionamiento	25 ± 3°C (77 ± 5°F)
Uso del Ciclo	Corriente de Carga Inicial inferior a 45 A de voltaje. 7.2~7.5V at 25°C (77°F) Temp. Coeficiente -15mV/°C
Uso en Espera	Sin límite en el Voltaje de Corriente de Carga Inicial. 6.75~6.9V a 25°C (77°F) Temp. Coeficiente -10mV/°C
Capacidad Afectada por Temperatura	40°C (104°F) 103%
	25°C (77°F) 100%
	0°C (32°F) 86%
Autodescarga	Las baterías pueden almacenarse hasta 6 meses a 25°C (77°F) y luego se requiere una carga de refresco.



### Dimensiones de la Batería

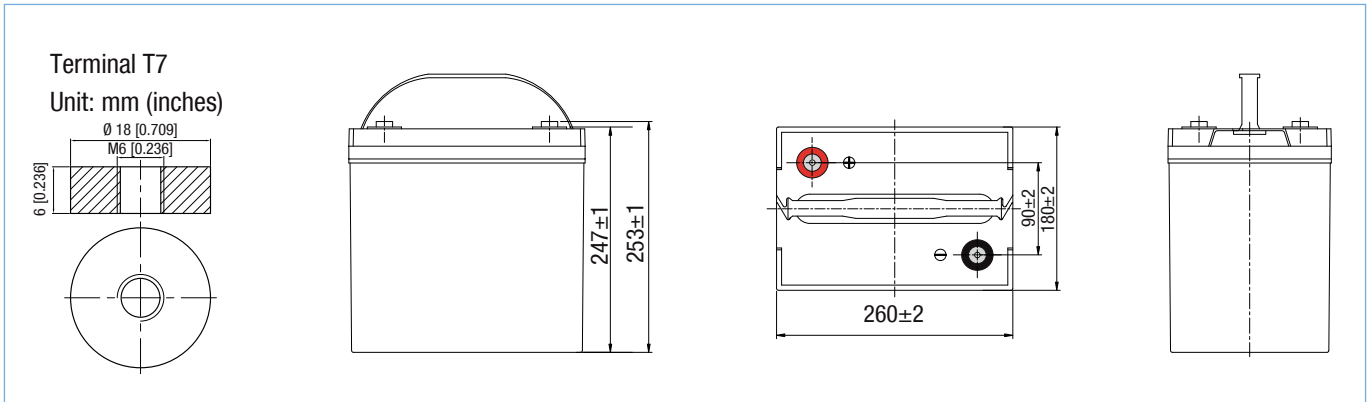

### Tablas de Descarga de la Batería

Descarga de Corriente Constante (Amperios) a 25°C (77°F)

F.V/Tiempo	5min	10min	15min	20min	30min	45min	1h	2h	3h	4h	5h	6h	8h	10h	20h
1.85V/celda	256.7	201.8	171.6	143.6	114.1	86.4	70.7	45.0	35.6	29.1	23.5	20.4	16.6	14.2	7.73
1.80V/celda	344.6	257.9	207.4	169.7	134.6	100.4	79.2	49.2	38.3	31.1	25.2	21.9	17.6	15.0	7.80
1.75V/celda	388.5	283.4	226.5	182.6	139.8	104.2	82.9	51.0	39.0	31.8	25.8	22.5	17.9	15.1	7.88
1.70V/celda	427.9	308.9	241.8	191.9	145.5	108.4	85.5	53.0	40.1	32.6	26.5	23.0	18.1	15.3	8.03
1.65V/celda	471.8	333.3	257.2	203.8	153.5	111.1	88.4	54.5	41.8	33.7	27.2	23.5	18.4	15.6	8.13
1.60V/celda	/	361.9	275.0	217.1	162.0	115.8	91.5	56.3	43.1	34.8	28.1	24.0	18.6	15.8	8.18

Descarga de Potencia Constante (Vatios) a 25°C (77°F)

F.V/Tiempo	5min	10min	15min	20min	30min	45min	1h	2h	3h	4h	5h	6h	8h	10h	20h
1.85V/celda	469.4	372.8	320.3	270.6	217.5	166.0	136.4	87.5	69.4	56.9	46.0	40.1	32.7	28.0	15.3
1.80V/celda	623.4	470.8	381.8	315.2	252.7	191.6	152.0	94.8	74.3	60.4	49.1	42.9	34.6	29.6	15.4
1.75V/celda	687.9	509.0	411.9	335.8	260.2	196.9	158.3	98.0	75.4	61.5	50.3	43.9	35.1	29.9	15.6
1.70V/celda	736.5	542.2	433.6	350.3	269.3	204.0	162.7	101.7	77.3	63.0	51.4	44.8	35.6	30.2	15.8
1.65V/celda	800.6	579.8	457.5	369.3	281.8	207.2	167.0	103.9	80.2	65.0	52.7	45.6	36.1	30.7	16.0
1.60V/celda	/	615.1	481.2	389.2	295.4	214.8	172.0	106.9	82.3	66.8	54.2	46.5	36.3	31.0	16.1



### Características de la Descarga

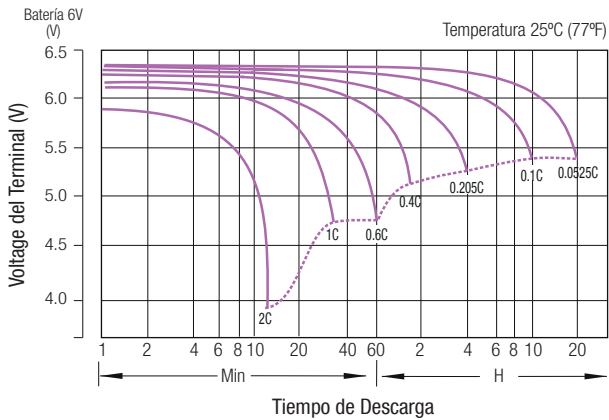

### Efecto de la Temperatura sobre la Vida Útil Flotante a Largo Plazo

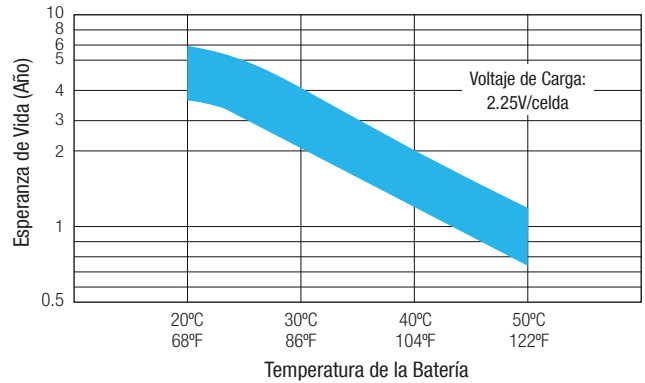

### Características de Carga Flotante

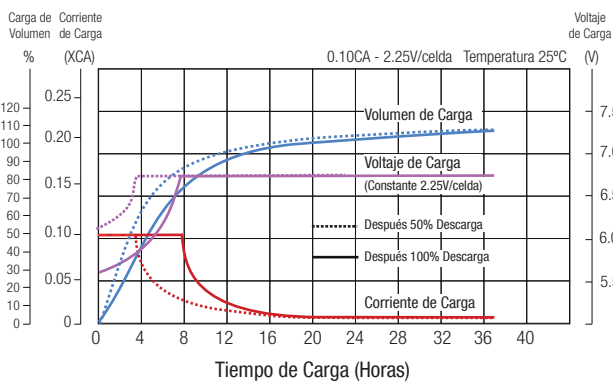

### Ciclo de Vida en relación con la Profundidad de Descarga

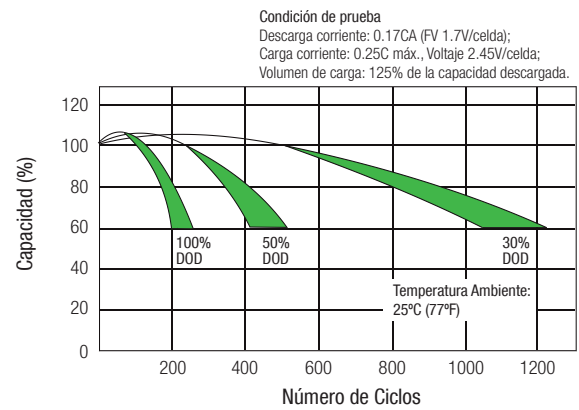

### Efectos de la Temperatura en relación con la Capacidad de la Batería

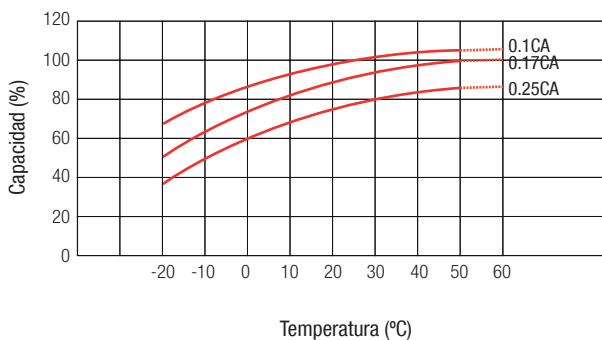

### Características de Autodescarga

