

Serie UP

UP100-6

USO GENERAL AGM

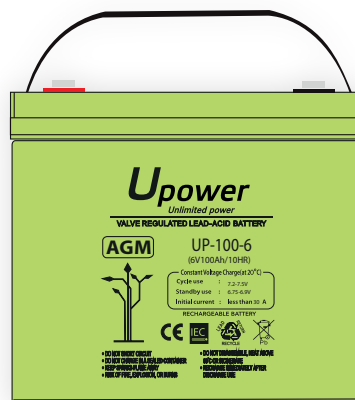

Características Principales

- **Máxima calidad y fiabilidad**

Exhaustivos procesos de control, desde la materia prima a la entrega del producto al cliente final, dentro de los estándares internacionales de calidad implementados en la compañía.

- **Válvulas de regulación de gases**

Diseñadas para una mejor recombinación de los gases con la mínima pérdida de hidrógeno, ayudan a la regulación interna de la presión, incrementando el rendimiento y la seguridad.

Especificaciones Técnicas

| | |
|--|--|
| Voltaje Nominal (V) | 6 |
| Capacidad Nominal (10 Hr) | 100.0 Ah |
| Dimensiones | Longitud: 195 ± 2mm (7.68 pulgadas) |
| | Anchura: 170 ± 2mm (6.69 pulgadas) |
| | Altura: 206.5 ± 3mm (8.13 pulgadas) |
| | Altura Total (+terminal) 212.5 ± 3mm (8.37 pulgadas) |
| Peso Aproximado | 15.6 Kg (34.4 libras) |
| Terminal | T6 |
| Material del Contenedor | ABS |
| Capacidad Clasificada | 104.0 Ah / 5.20 A (20hr, 1.80V/celda, 25°C/77°F) |
| | 100.0 Ah / 10.0 A (10hr, 1.80V/celda, 25°C/77°F) |
| | 86.0 Ah / 17.2 A (5hr, 1.75V/celda, 25°C/77°F) |
| | 78.0 Ah / 26.0 A (3hr, 1.75V/celda, 25°C/77°F) |
| | 61.0 Ah / 61.0 A (1hr, 1.60V/celda, 25°C/77°F) |
| Corriente Máxima de Descarga | 1200 A (5s) |
| Resistencia Interna | Aprox. 5.0 mΩ |
| Rango de Temperatura de Funcionamiento | Descarga: -15 ~ 50°C (5 ~ 122°F) |
| | Carga: 0 ~ 40°C (32 ~ 104°F) |
| | Almacenamiento: -15 ~ 40°C (5 ~ 104°F) |
| Rango de Temperatura Nominal de Funcionamiento | 25 ± 3°C (77 ± 5°F) |
| Uso del Ciclo | Corriente de Carga Inicial inferior a 30 A de voltaje. 7.2~7.5V a 25°C (77°F) Temp. Coeficiente -15mV/°C |
| Uso en Espera | Sin límite en el Voltaje de Corriente de Carga Inicial. 6.75~6.9V a 25°C (77°F) Temp. Coeficiente -10mV/°C |
| Capacidad Afectada por Temperatura | 40°C (104°F) 103% |
| | 25°C (77°F) 100% |
| | 0°C (32°F) 86% |
| Autodescarga | Las baterías pueden almacenarse hasta 6 meses a 25°C (77°F) y luego se requiere una carga de refresco. |



ACREDITADO POR ENAC



ACREDITADO POR ENAC



Dimensiones de la Batería

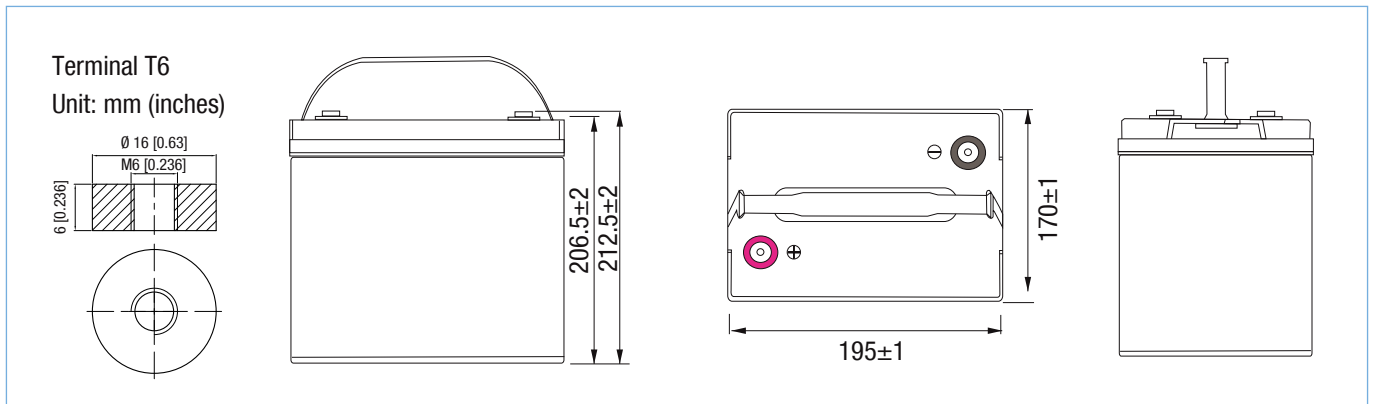

Tablas de Descarga de la Batería

Descarga de Corriente Constante (Amperios) a 25°C (77°F)

| F.V/Tiempo | 5min | 10min | 15min | 20min | 30min | 45min | 1h | 2h | 3h | 4h | 5h | 6h | 8h | 10h | 20h |
|-------------|-------|-------|-------|-------|-------|-------|------|------|------|------|------|------|------|------|------|
| 1.85V/celda | 171.2 | 134.6 | 114.4 | 95.7 | 76.1 | 57.6 | 47.1 | 30.0 | 23.7 | 19.4 | 15.6 | 13.6 | 11.0 | 9.44 | 5.15 |
| 1.80V/celda | 229.7 | 171.9 | 138.3 | 113.1 | 89.8 | 67.0 | 52.8 | 32.8 | 25.6 | 20.7 | 16.8 | 14.6 | 11.7 | 10.0 | 5.20 |
| 1.75V/celda | 259.0 | 188.9 | 151.0 | 121.7 | 93.2 | 69.5 | 55.3 | 34.0 | 26.0 | 21.2 | 17.2 | 15.0 | 11.9 | 10.1 | 5.25 |
| 1.70V/celda | 285.2 | 205.9 | 161.2 | 127.9 | 97.0 | 72.3 | 57.0 | 35.3 | 26.8 | 21.7 | 17.7 | 15.3 | 12.1 | 10.2 | 5.35 |
| 1.65V/celda | 314.5 | 222.2 | 171.4 | 135.9 | 102.3 | 74.1 | 58.9 | 36.3 | 27.9 | 22.5 | 18.1 | 15.6 | 12.3 | 10.4 | 5.42 |
| 1.60V/celda | 346.9 | 241.3 | 183.4 | 144.8 | 108.0 | 77.2 | 61.0 | 37.6 | 28.7 | 23.2 | 18.7 | 16.0 | 12.4 | 10.5 | 5.45 |

Descarga de Potencia Constante (Vatios) a 25°C (77°F)

| F.V/Tiempo | 5min | 10min | 15min | 20min | 30min | 45min | 1h | 2h | 3h | 4h | 5h | 6h | 8h | 10h | 20h |
|-------------|-------|-------|-------|-------|-------|-------|-------|------|------|------|------|------|------|------|------|
| 1.85V/celda | 312.9 | 248.6 | 213.5 | 180.4 | 145.0 | 110.7 | 90.9 | 58.3 | 46.3 | 37.9 | 30.6 | 26.8 | 21.8 | 18.7 | 10.2 |
| 1.80V/celda | 415.6 | 313.9 | 254.5 | 210.1 | 168.5 | 127.7 | 101.3 | 63.2 | 49.5 | 40.3 | 32.8 | 28.6 | 23.1 | 19.8 | 10.3 |
| 1.75V/celda | 458.6 | 339.3 | 274.6 | 223.9 | 173.5 | 131.1 | 105.5 | 65.3 | 50.2 | 41.0 | 33.5 | 29.3 | 23.4 | 19.9 | 10.4 |
| 1.70V/celda | 491.0 | 361.5 | 289.1 | 233.5 | 179.5 | 136.0 | 108.5 | 67.8 | 51.5 | 42.0 | 34.3 | 29.8 | 23.7 | 20.1 | 10.6 |
| 1.65V/celda | 533.7 | 386.5 | 305.0 | 246.2 | 197.8 | 138.1 | 111.3 | 69.3 | 53.5 | 43.3 | 35.1 | 30.4 | 24.0 | 20.5 | 10.7 |
| 1.60V/celda | 575.1 | 410.1 | 320.8 | 259.4 | 196.9 | 143.2 | 114.7 | 71.2 | 54.9 | 44.5 | 36.2 | 31.0 | 24.2 | 20.7 | 10.8 |



Características de la Descarga

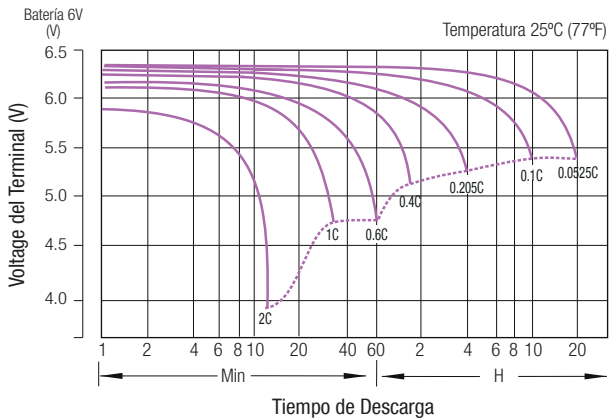

Efecto de la Temperatura sobre la Vida Útil Flotante a Largo Plazo

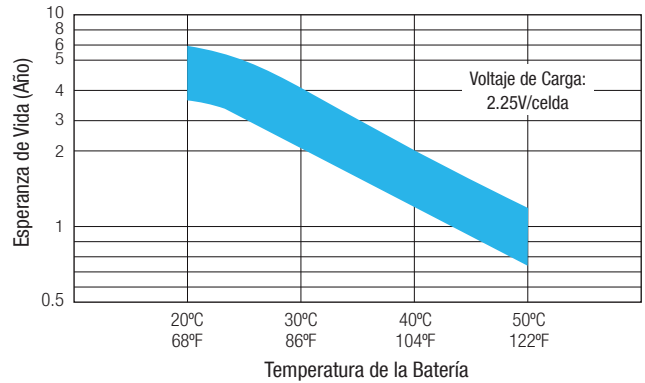

Características de Carga Flotante

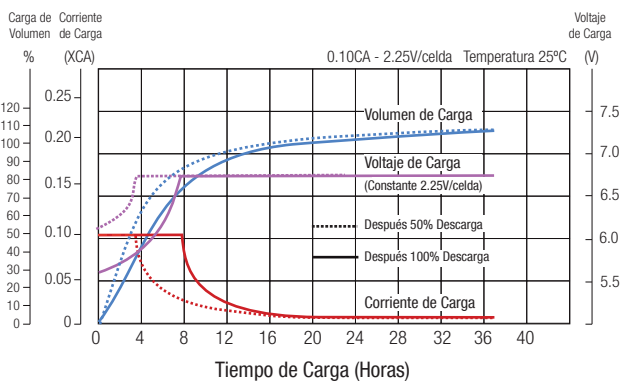

Ciclo de Vida en relación con la Profundidad de Descarga

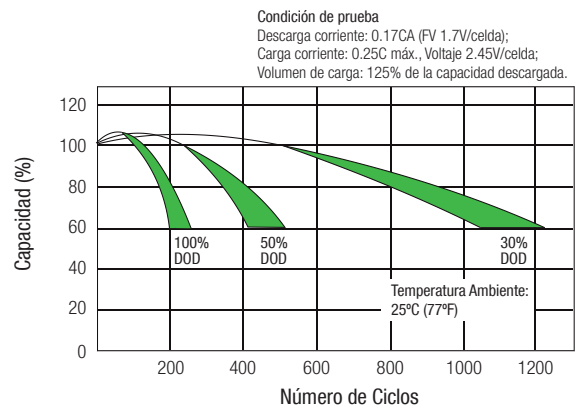

Efectos de la Temperatura en relación con la Capacidad de la Batería

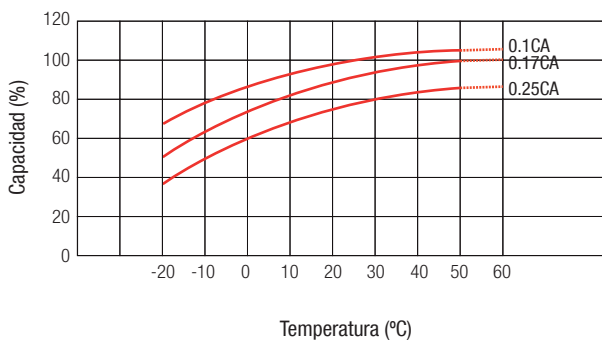

Características de Autodescarga

