

UP Series CG30-12

C A R B O N G E L



Main Features

- The carbon can greatly slow down the sulfate of negative plate due to the PSOC cycle application.
- Excellent partial stage of charge (PSOC) cycle performance.
- Excellent recharge acceptance performance, super fast charge / large discharge performance.
- Excellent temperature tolerance, capacity increased 16% at -20°C.

Complied Standards

- IEC 61056
- JIS C8702
- UL1989
- GB/T19639

12 V
voltage

30 Ah
capacity

GEL
technology

12 years
design life



Technical Specifications

Nominal Voltage (V)	12 (6 cells per unit)
Designed Floating Life (20°C)	12 Years
Nominal Capacity (25°C)	30 Ah @ 20 Hr - rate (to 1.75 Vpc) 35 Ah @ 100 Hr - rate (to 1.75 Vpc)
Dimension, L x W x H (mm)	181 x 76 x 170
Approx. Weight	6.8 Kg (14.99 lbs)
Terminal Type	Terminal T5
Internal Resistance	Approx. 0.012 Ω (fully charged @ 25°C)
Maximum Charge Current	5 A
Maximum Discharge Current (5S)	200 A
Short Circuit Current	600 A
Self Discharge	Approx. 3% per month @ 20°C
Ambient Temperature	Discharge: -15 ~ 55°C Charge: -15 ~ 45°C Storage: -15 ~ 45°C
Float Charge Voltage (20~25°C)	13.7 - 13.9 V (-3 mV / cell / °C)
Equalize and Cycle Use Charge Voltage (20~25°C)	14.3 - 14.6 V (-5 mV / cell / °C)
Container Material	ABS (UL94-V0 optional)

Battery Dimensions

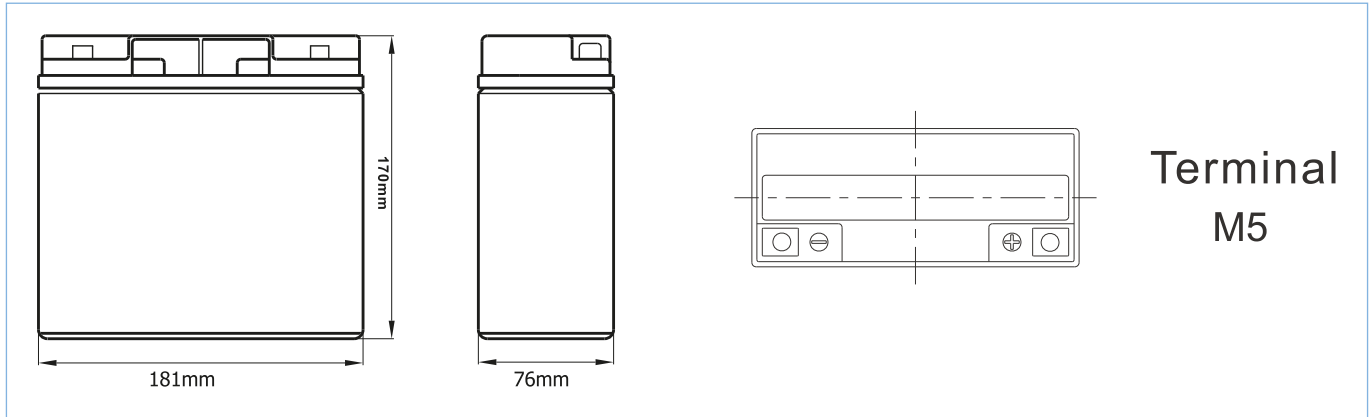

Battery Discharge Table

Constand Current Discharge (25°C)												
F.V/Time	1 HR		3 HR		5 HR		10 HR		20 HR		100 HR	
	Current (Amps)	Capacity (Ah)	Current (Amps)	Capacity (Ah)	Current (Amps)	Capacity (Ah)	Current (Amps)	Capacity (Ah)	Current (Amps)	Capacity (Ah)	Current (Amps)	Capacity (Ah)
1.75 V	17	17	6.7	20	4.5	22.5	2.6	26	1.43	30	0.35	35

Note: The above data are average values, and can be obtained within 5 charge / discharge cycles. These are not minimum values. Cell and battery designs / specifications are subject to modification without notice. Contact UPOWER, LTD for the latest information.

Performance Curve

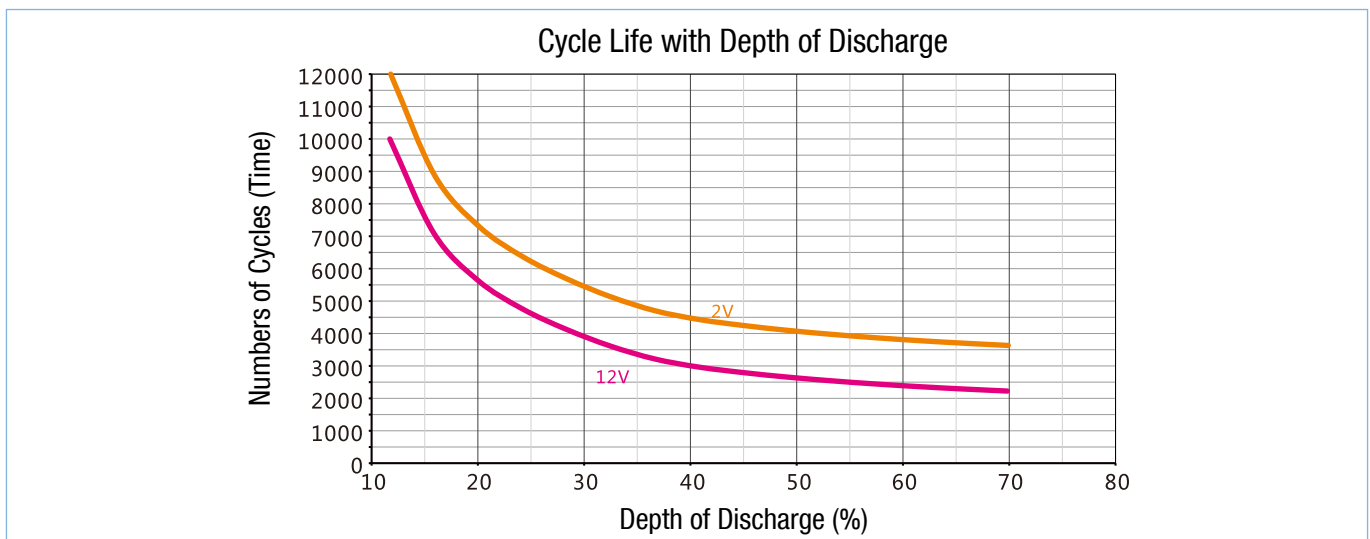

Discharging Characteristics (25°C / 77°F)

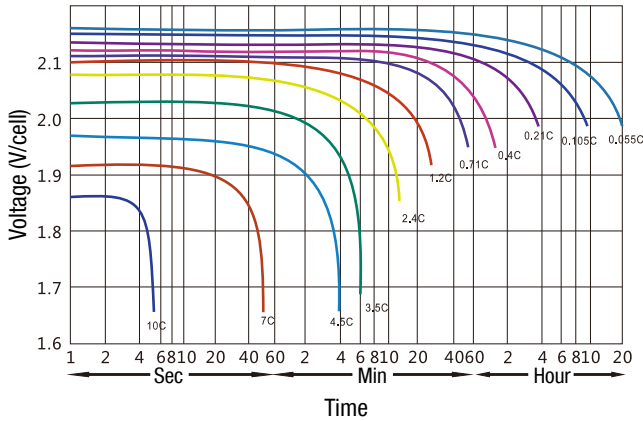

Charge Characteristic Curve

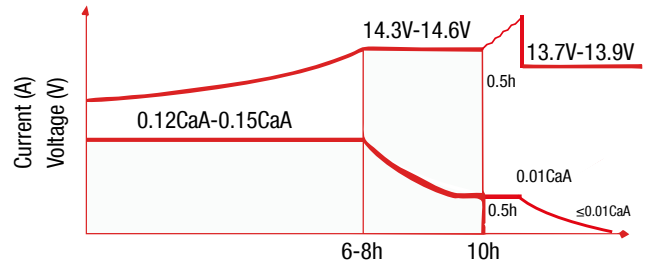

Step 1: Constant current charging with 0.12-0.15CaA until voltage reach to 14.3-14.6V
 Step 2: Constant voltage charging with 14.3-14.6V until current is less than 0.01CaA
 Step 3: Constant current charging with 0.01CaA for 0.5h
 Step 4: Float charging at voltage 13.7-13.9V

Cycle Life with Depth of Discharge

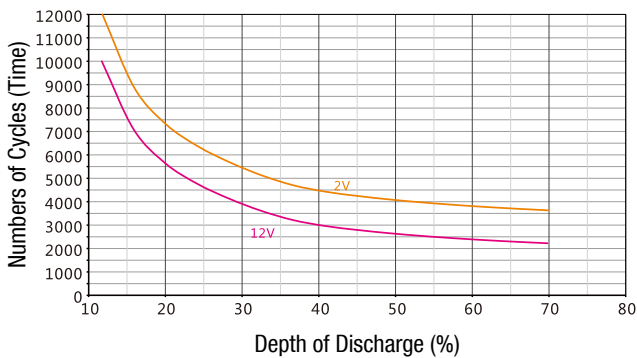

Capacity Effected by Temperature

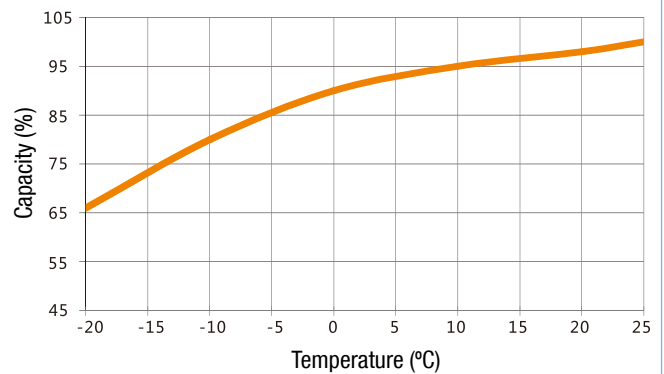

Self Discharge Characteristics

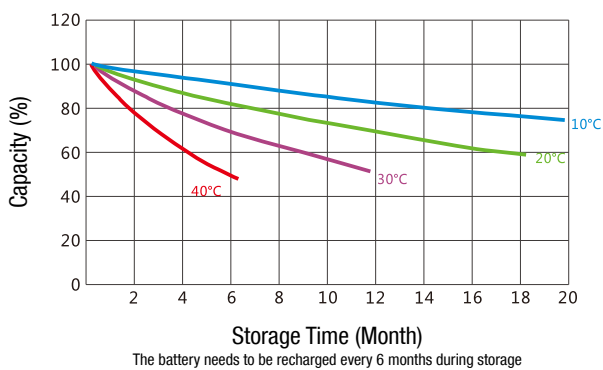

Charging Time with Depth of Discharge

