

# LITHIUM BATTERIES

## LiFePO<sub>4</sub>

# Upower

ecoline



## UE SERIES

# UE-12Li300



# 12.8 V



# 300 Ah

MASTER  
BATTERY



Paseo de Extremadura, 39 - 28935 Móstoles - Madrid (Spain)  
Tel. +34 918 021 649 - Fax. +34 917 750 542  
info@masterbattery.es - www.masterbattery.es/en

  
zeroCO<sub>2</sub>

# UE-12Li300

# UE SERIES

## PRODUCT DESCRIPTION

Lithium-ferrophosphate (LiFePO<sub>4</sub>) battery designed to replace lead-acid with better performance:

- Very high energy density and capacity.
- Longer useful life.
- Greater safety (no maintenance).
- Parallelisable and can be assembled up to 4 units (4x4).

## APPLICATIONS

- UPS/EPS
- TELECOM
- Accumulation of solar surplus
- Autonomous mobility

## MAIN TECHNICAL SPECIFICATIONS

Rated Capacity:		300 Ah
Rated Voltage:		12.8 V
Recommended Charge Current:	(0.2 C)	60 A
Maximum Charge Current (*):		100 A
Recommended Discharge Current:	(0.2 C)	60 A
Maximum Discharge Current (*):		200 A
Life Cycles:	(100% DoD)	2500 cycles
Operating Temperature:	Charge:	0°C ~ 45°C
	Discharge:	-20°C ~ 60°C
Storage Temperature:		-10°C ~ 35°C

(\* ) Charging and discharging at higher than recommended currents can cause a decrease in the performance and life expectancy of the battery.

## DIMENSIONS

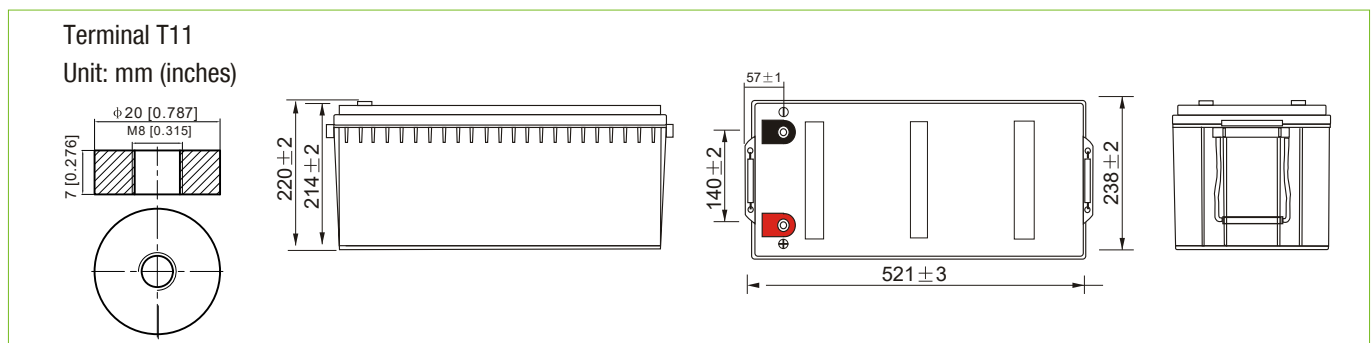

OPERATING CURVES

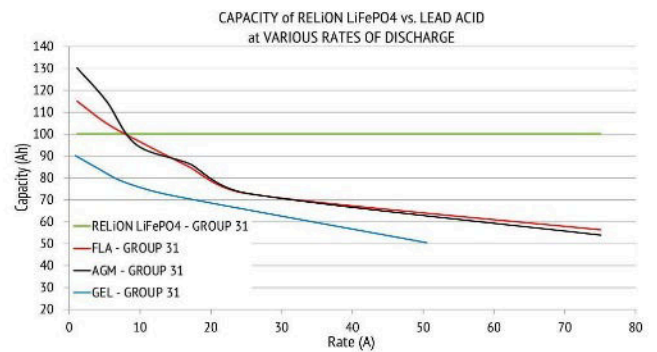
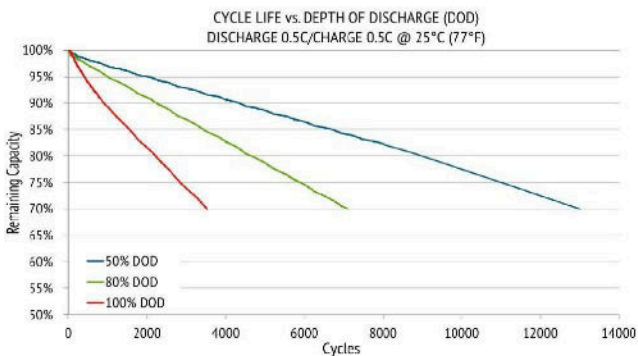
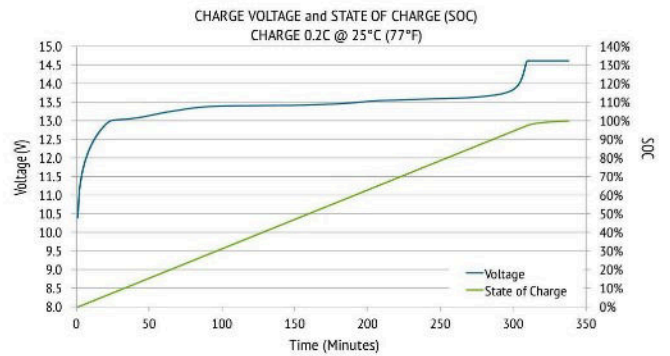
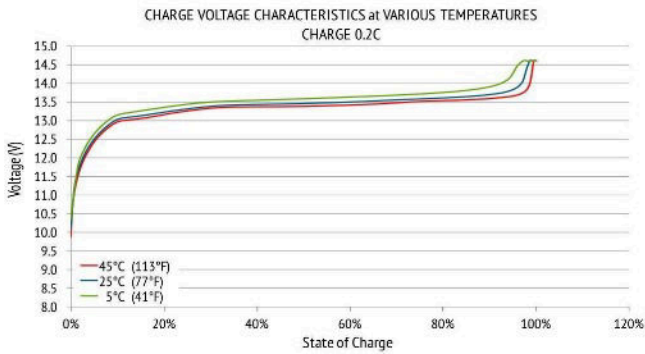
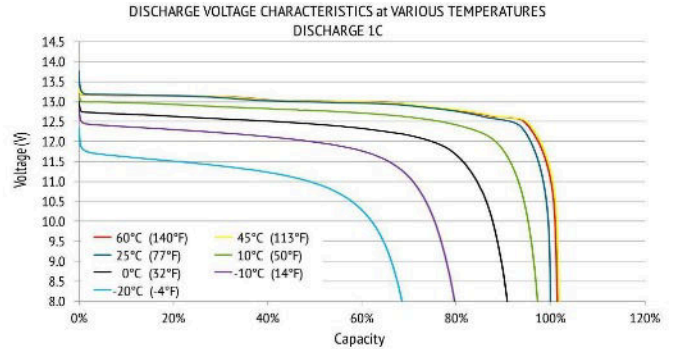
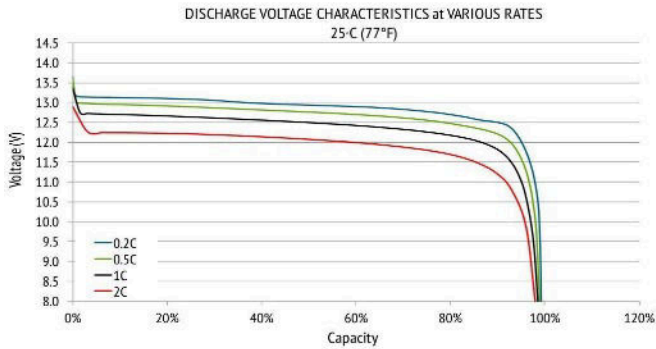

# UE-12Li300

## UE SERIES

### ELECTRICAL SPECIFICATIONS

Charge Voltage:	14.6 V
Discharge Cutoff Voltage:	10 V
Internal Resistance:	≤ 10 mΩ

### OTHER SPECIFICATIONS

Dimensions (L x W x H):	521 x 238 x 220 mm
Weight:	Approx. 28 kg
Output Connector:	M8

### PROTECTIONS

- Overload Protection
- Overload Protection
- Load/Discharge Overvoltage Protection
- Short Circuit Protection
- Excessive Temperature Protection

### CERTIFICATIONS

UN 38.8 MSDS , DG certificate, CE

