

LITHIUM BATTERIES LiFePO₄

Upower ecoline



UE SERIES UE-12Li150



12.8 V



150 Ah

MASTER
BATTERY



Paseo de Extremadura, 39 - 28935 Móstoles - Madrid (Spain)
Tel. +34 918 021 649 - Fax. +34 917 750 542
info@masterbattery.es - www.masterbattery.es/en

zeroCO₂

UE-12Li150

UE SERIES

PRODUCT DESCRIPTION

Lithium-ferrophosphate (LiFePO₄) battery designed to replace lead-acid with better performance:

- Very high energy density and capacity.
- Longer useful life.
- Greater safety (no maintenance).
- Parallelisable and can be assembled up to 4 units (4x4).

APPLICATIONS

- UPS/EPS
- TELECOM
- Accumulation of solar surplus
- Autonomous mobility

MAIN TECHNICAL SPECIFICATIONS

Rated Capacity:		150 Ah
Rated Voltage:		12.8 V
Recommended Charge Current:	(0.2 C)	30 A
Maximum Charge Current (*):		150 A
Recommended Discharge Current:	(0.2 C)	30 A
Maximum Discharge Current (*):		150 A
Life Cycles:	(100% DoD)	2500 cycles
Operating Temperature:	Charge:	0°C ~ 45°C
	Discharge:	-20°C ~ 60°C
Storage Temperature:		-10°C ~ 35°C

(*) Charging and discharging at higher than recommended currents can cause a decrease in the performance and life expectancy of the battery.

DIMENSIONS

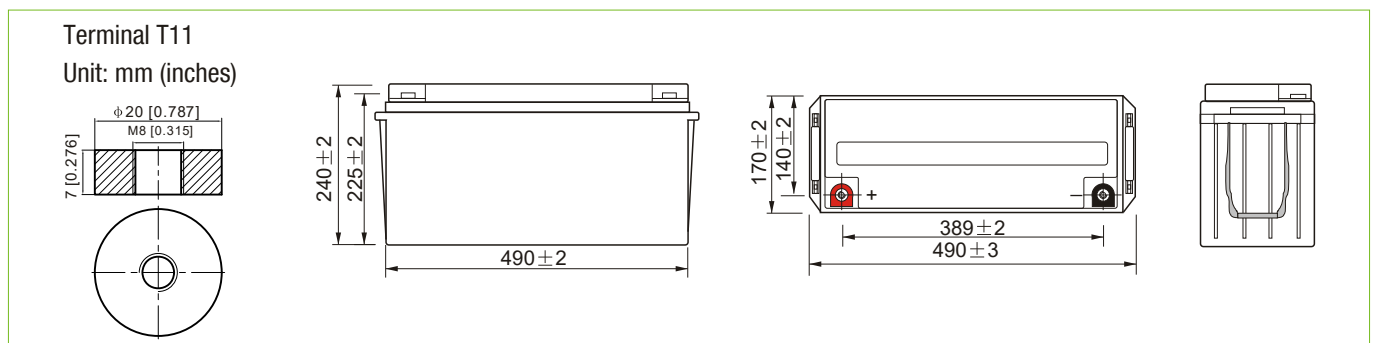

OPERATING CURVES

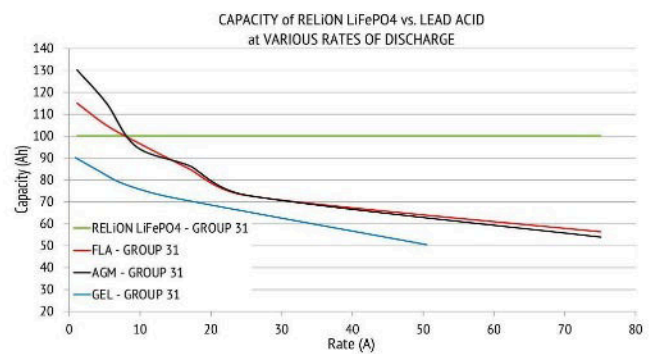
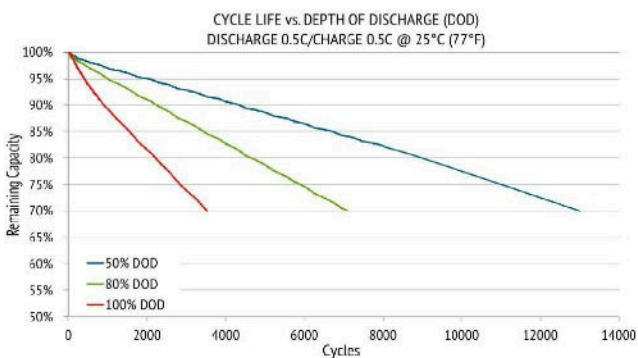
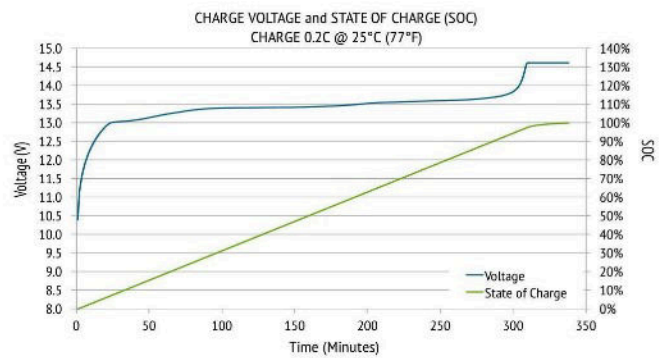
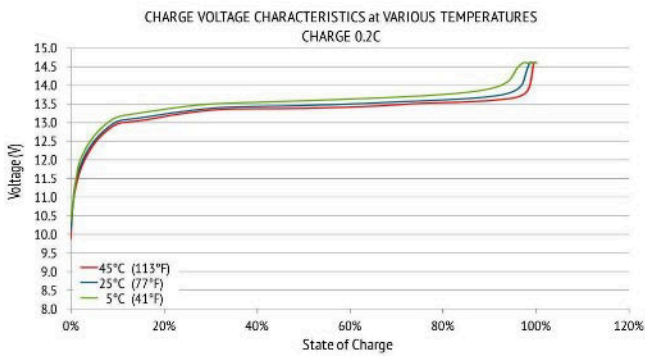
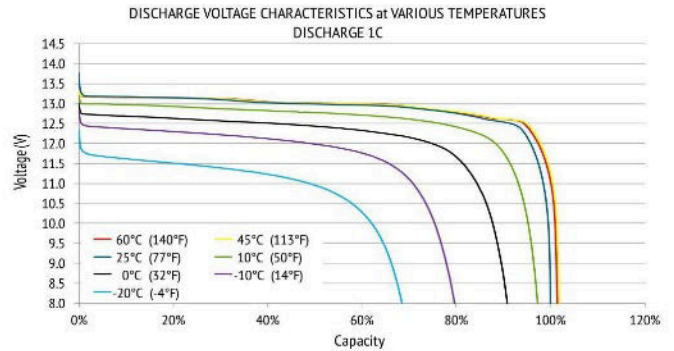
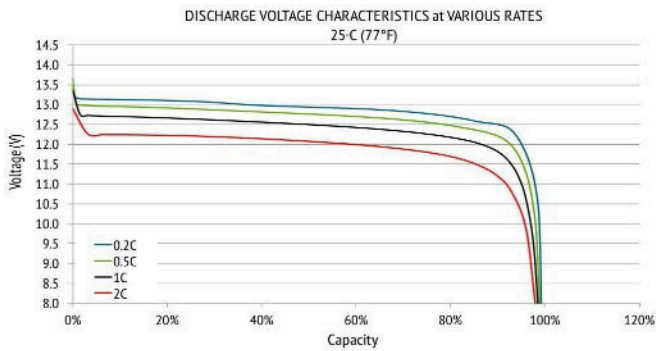

UE-12Li150

UE SERIES

ELECTRICAL SPECIFICATIONS

Charge Voltage:	14.6 V
Discharge Cutoff Voltage:	10 V
Internal Resistance:	≤ 10 mΩ

OTHER SPECIFICATIONS

Dimensions (L x W x H):	490 x 170 x 240 mm
Weight:	Approx. 14.5 kg
Output Connector:	M8

PROTECTIONS

- Overload Protection
- Overload Protection
- Load/Discharge Overvoltage Protection
- Short Circuit Protection
- Excessive Temperature Protection

CERTIFICATIONS

UN 38.8 MSDS , DG certificate, CE

