

Lista de piezas de montaje



Tornillos M5 x 30/32 piezas



Pasador de puerta x1



Bloqueo x1



Llave L x1



Perfil de montaje x 4

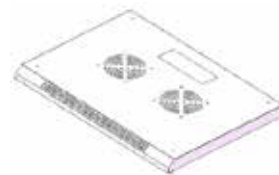

Cubierta superior x1



Marco x 2



Parte inferior x1

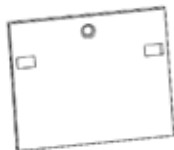

Panel lateral x 2

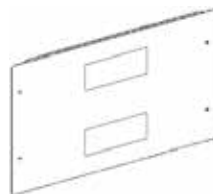

Panel trasero x1

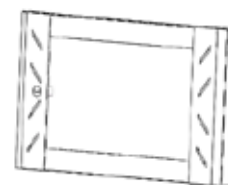

Puerta de cristal x1

Vista detallada

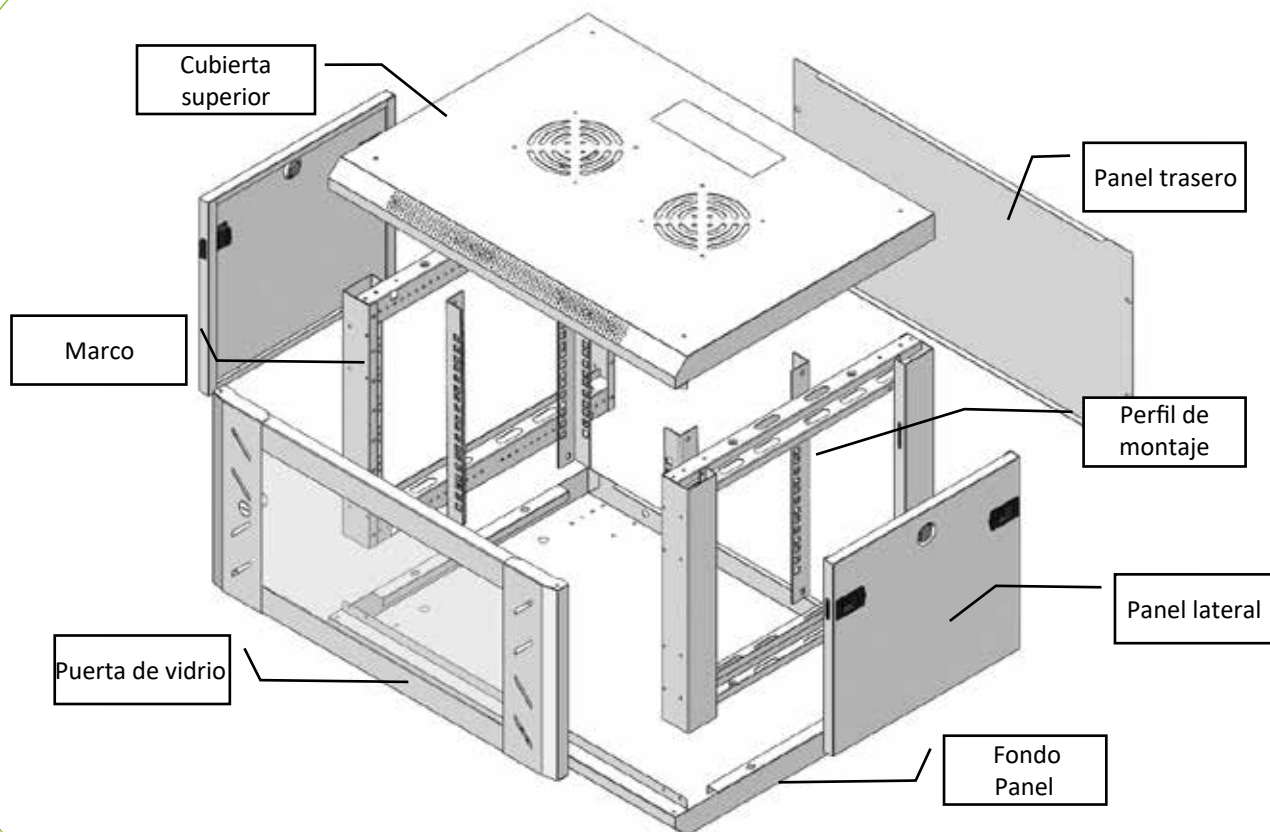

▶▶▶▶ Paso 1: fija el marco;

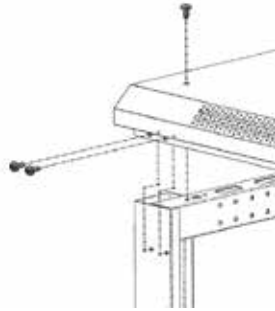
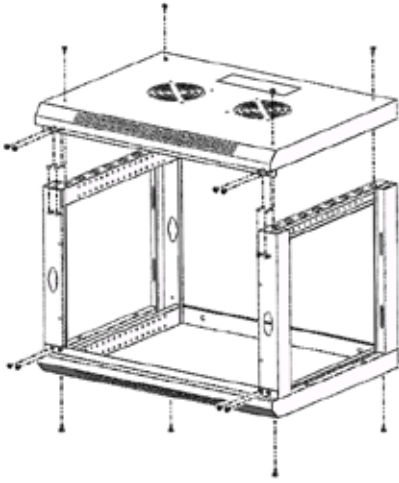

Fije la cubierta superior y la parte inferior con tornillos de 8 piezas; Luego fije el marco frontal con 8 tornillos.

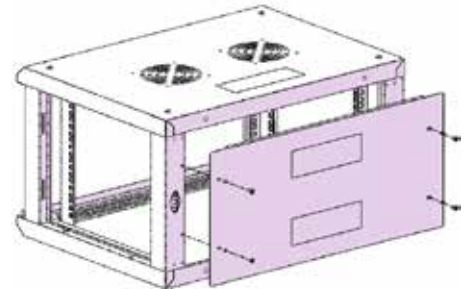

Fije el panel trasero con 4 tornillos. Armario 12U/15U/18U por favor fije 6 piezas de tornillos

▶▶▶▶ Paso 2: fija el perfil de montaje;

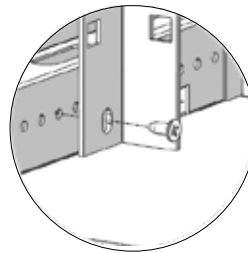
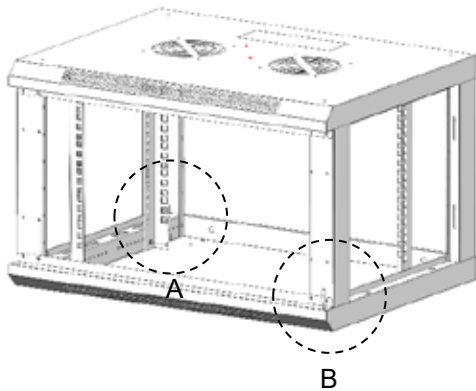

A Detalle

Fije los perfiles de montaje de 4 piezas en el Marco con 8 tornillos. Fije 1 tornillo en la parte superior e inferior de cada perfil de montaje.

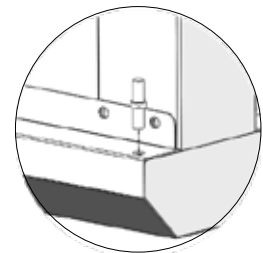

B Detalle

Fijar el pasador de la puerta

▶▶▶▶ Paso 3: arregla la puerta y el panel;

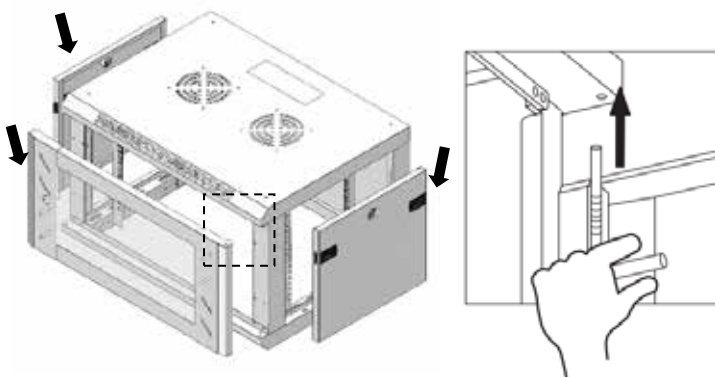

Fijar la cerradura de la puerta principal; Por último, instale los paneles laterales

Las ruedas y los pies son opcionales

