

UP-R600-2



ISO 9001, ISO 14001, OHSAS 18001, AQAP 2110

Product characteristics

- Valve-regulated lead-acid battery
- Stationary and reserve power applications
- EUROBAT design life definition: Very Long Life 12+ years
- Extremely high float life performance
- Superior cycling endurance
- Compact design with high energy density
- ETSI Rack integration
- Low installation cost, maintenance free product
- Sealed for leak-free operation
- Delivered ready for use
- Non-hazardous cargo for ground, sea and air transport
- Fully recyclable product

Physical characteristics

	SI Units	US Units
Length	389 mm	15.31 inches
Width	171 mm	6.73 inches
Height	238 mm	9.37 inches
Weight	37.3 kg	82.23 lbs

Technical Specifications

Electrical specifications:

Nominal voltage	2V
Number of cells	1
Rated capacity	600 Ah (10 h rate to 1.80 Vpc at 20 °C) 599 Ah (8 h rate to 1.75 Vpc at 25 °C)
Internal resistance	0.28 mOhm (IEC 60 896 -21/22)
Short circuit current	6700 A (IEC 60 896 -21/22)
Float charge voltage	2.27 V per cell (Vpc) at 20°C

Design features:

Design life at 20 °C	Very Long Life 12+ years
Plates	Tick Flat Pasted
Active material	Very high purity virgin lead
Grid alloy	Lead-Calcium-Tin alloy
Electrolyte	Sulphuric acid, Analytical grade
Separator	Absorbing Glass Mat (AGM)
Operating temperature	-20 °C to +60 °C (maximum) +15 °C to +25 °C (recommended)
Venting valve	One way, self resealing - Opening pressure: 1.7 PSI - Resealing pressure: 1.5 PSI
Internal gas recombination efficiency	more than 99%
Central degassing system	N/A
Flame arrester	N/A
Storage temperatures	-20°C to +40°C
Self discharge	Less than 2.0% per month at 20°C
Storability without recharging	Up to 6 months at 20°C
Shelf life	Up to 1 year
Container / lid material	Shock resistant ABS FR; flammability class UL94 V0
Terminal position	Top
Terminal sealing	Mechanical + epoxy double sealing
Terminal type	Brass; Female; M8 thread
Terminal torque	8 Nm
Terminal cover	Available
Carrying Handles	Available (2)
Connectors and bolts	Supplied as standard

Applicable standards:

- IEC 60896 - 21/22
- IEC 61427 - 1/2
- IEEE 1184
- EN 50272 - 2
- IEC 61056 - 1
- IEEE 1187 / 1188



UP-R600-2

Drawings

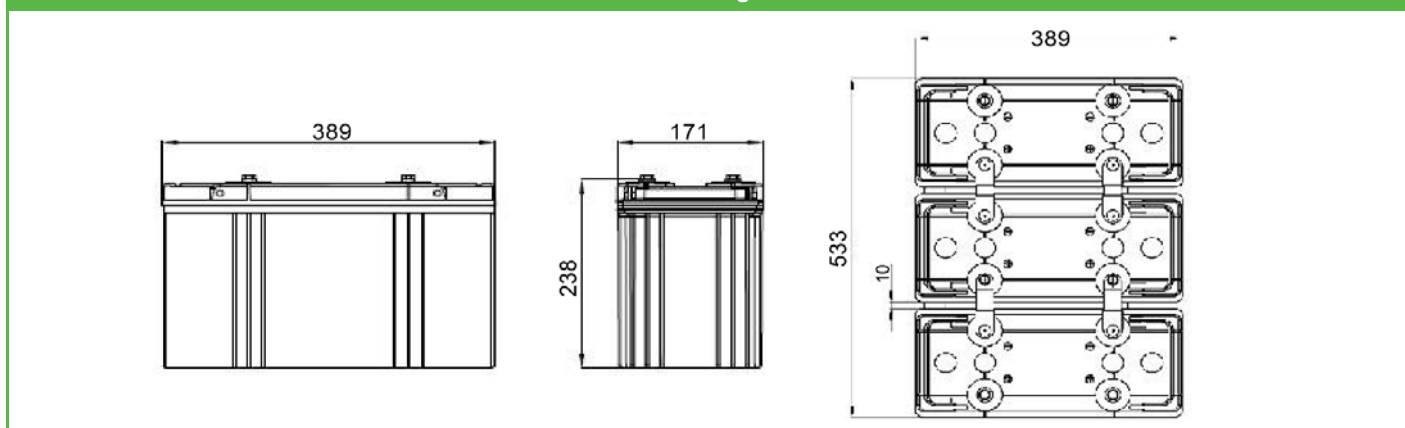

Battery discharge performance at 20°C

Temperature correction factor of capacity at constant current discharge

Discharge time	-10°C	0°C	10°C	15°C	20°C	25°C	30°C	35°C	40°C	45°C
From 5 to 59 minutes	0.70	0.80	0.90	0.95	1	1.05	1.10	1.13	1.15	1.16
From 1 to 20 hours	0.82	0.88	0.94	0.97	1	1.03	1.05	1.08	1.09	1.10

Battery capacity at constant current discharge (Ah) for battery at 20°C

Uf, Vpc	5 min	15 min	30 min	1 h	2 h	3 h	4 h	5 h	6 h	8 h	10 h	20 h
1.60	127	216	309	376.8	438.6	481.8	513.0	537.6	556.2	593.4	618.0	661.2
1.65	125	215	308	375.0	436.8	480.0	510.6	535.2	553.8	590.4	615.0	657.6
1.70	122	214	306	373.2	434.4	477.6	508.2	532.2	550.8	587.4	612.0	654.6
1.75	121	212	303	369.6	430.2	472.8	502.8	527.4	545.4	582.0	606.0	648.0
1.80	120	210	300	366.0	426.0	468.0	498.0	522.0	540.0	576.0	600.0	642.0
1.85	117	205	293	357.0	415.2	456.0	486.0	508.8	526.8	561.6	585.0	625.8

Discharge performance at constant current discharge (A) for battery at 20°C

Uf, Vpc	5 min	15 min	30 min	1 h	2 h	3 h	4 h	5 h	6 h	8 h	10 h	20 h
1.60	1520	864	618	376.8	219.3	160.6	128.3	107.5	92.7	74.2	61.8	33.06
1.65	1495	862	616	375.0	218.4	160.0	127.7	107.0	92.3	73.8	61.5	32.88
1.70	1469	857	612	373.2	217.2	159.2	127.1	106.4	91.8	73.4	61.2	32.73
1.75	1455	850	606	369.6	215.1	157.6	125.7	105.5	90.9	72.8	60.6	32.40
1.80	1441	840	600	366.0	213.0	156.0	124.5	104.4	90.0	72.0	60.0	32.10
1.85	1405	818	586	357.0	207.6	152.0	121.5	101.8	87.8	70.2	58.5	31.29

Discharge performance at constant power discharge (W per cell) for battery at 20°C

Uf, Vpc	5 min	15 min	30 min	1 h	2 h	3 h	4 h	5 h	6 h	8 h	10 h	20 h
1.60	3038	1728	1236	753.6	438.6	321.2	256.6	215.0	185.4	148.3	123.6	66.12
1.65	2952	1723	1231	750.0	436.8	320.0	255.4	214.1	184.6	147.6	123.0	65.76
1.70	2930	1714	1224	746.4	434.4	316.8	254.2	212.9	183.6	146.9	122.4	65.46
1.75	2909	1699	1212	739.2	430.2	313.6	251.4	211.0	181.8	144.8	121.2	64.80
1.80	2880	1680	1200	732.0	426.0	312.0	249.0	208.8	180.0	144.0	120.0	64.20
1.85	2808	1637	1171	714.0	415.2	304.0	243.0	203.5	175.6	140.4	117.00	62.58



UP-R600-2

Battery charge conditions at 20°C

Charge regime: constant voltage and limited current (IU)

Charge current limit	Float charge voltage	Equalization charge voltage	Boost charge voltage
0.1 - 0.25C ₁₀ A Recommended: 0.20C ₁₀ A	2.27 V per cell at 20°C; Temperature correction: -3 mV / cell / °C	2.32 V per cell at 20°C Recommended: every 3 months for 24h during long time float operation	2.40 V per cell at 20°C Temperature correction: -4 mV / cell / °C
Float application: 0.20C ₁₀ A / 2.27 V per cell at 20°C		Cycling applications: 0.20C ₁₀ A / 2.40 V per cell at 20°C; Recharge Ah input at least 105% from previous discharge Ah	

