

User Manual

for Beta Series Hybrid Inverter



Applicable models

MF-BETA-RHI3P5KV2

MF-BETA-RHI3P6KV2

MF-BETA-RHI3P8KV2

MF-BETA-RHI3P10KV2

Applicable System

Three phase system

1. Introduction	02
1.1 Product Description	02
1.2 Packaging	03
2. Safety & Warning	04
2.1 Safety	04
2.2 General Safety Instructions	04
2.3 Notice For Use	06
2.4 Notice for Disposal	06
3. Overview	07
3.1 Intelligent LED Indicators	07
4. Installation	08
4.1 Select a Location for the Inverter	08
4.2 Mounting the Inverter	09
4.3 PE Cable Installation	11
4.4 PV Input Cable Installation	12
4.5 Battery Power Cable Installation	15
4.6 AC Cable Installation	16
4.7 Communication Cable Installation	21
4.8 Meter Installation	26
4.9 Inverter Remote Monitoring Connection	29
5. Commissioning & Shutdown	30
5.1 Preparation of Commissioning	30
5.2 Commissioning Procedure	30
5.3 Shutdown procedure	33
6. Maintenance	34
7. Troubleshooting	35
8. Specifications	40

1.1 Product Description

The Beta Series is designed for residential hybrid systems, which can work with batteries to optimize self-consumption. The unit can operate in both off- and on-grid modes.

This manual covers the Beta Series inverter model listed below:

MF-BETA-RHI3P5KV2, MF-BETA-RHI3P6KV2, MF-BETA-RHI3P8KV2,
MF-BETA-RHI3P10KV2

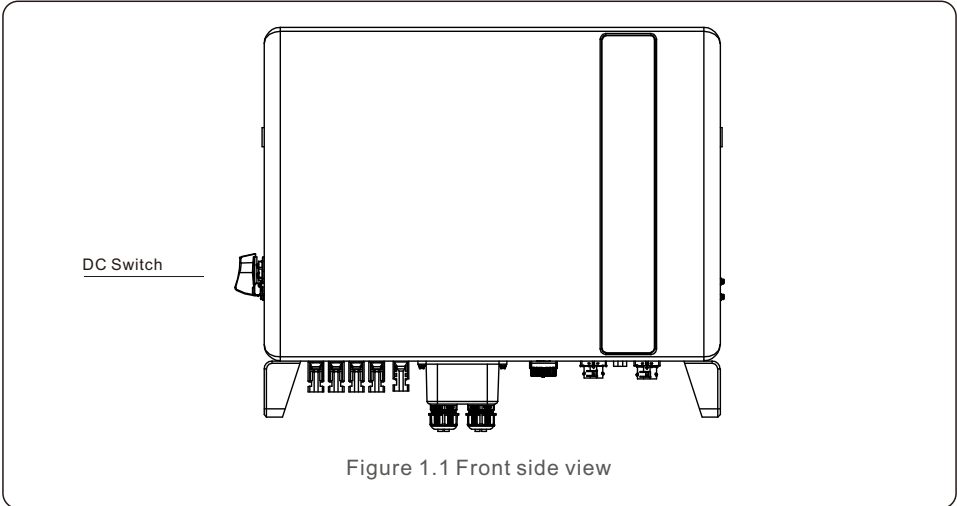

Figure 1.1 Front side view

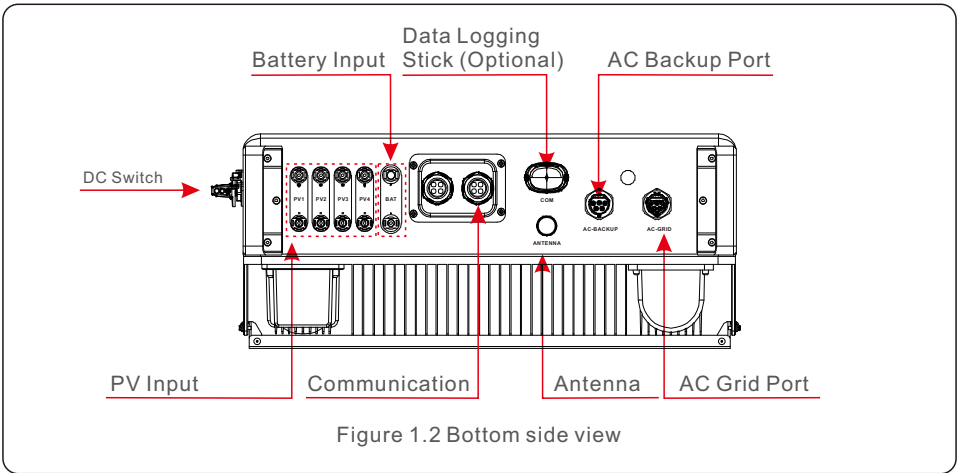
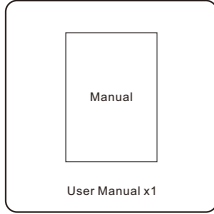
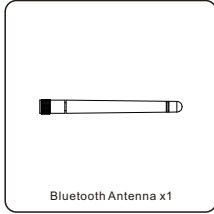
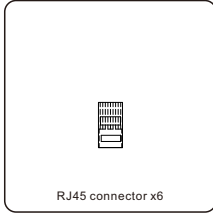
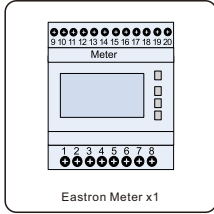
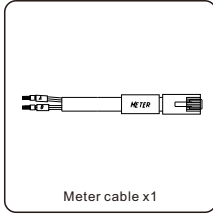
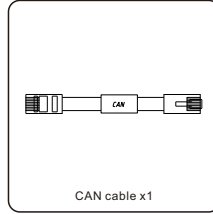
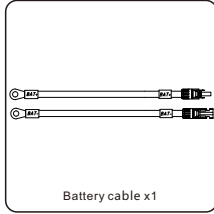
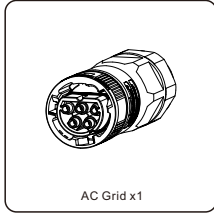
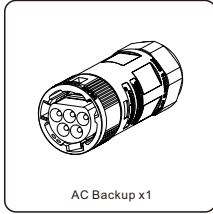
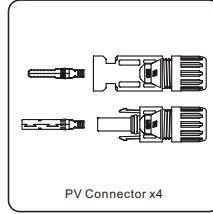
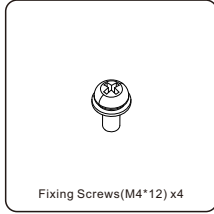
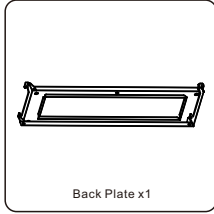
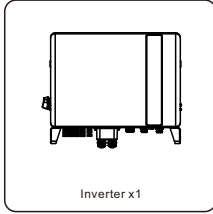

Figure 1.2 Bottom side view

1.2 Packaging

Please ensure that the following items are included in the packaging with your machine:



If anything is missing, please contact your local Beta distributor.

2.1 Safety

The following types of safety instructions and general information appear in this document as described below:



DANGER:

“Danger” indicates a hazardous situation which if not avoided, will result in death or serious injury.



WARNING:

“Warning” indicates a hazardous situation which if not avoided, could result in death or serious injury.



CAUTION:

“Caution” indicates a hazardous situation which if not avoided, could result in minor or moderate injury.



NOTE:

“Note” provides tips that are valuable for the optimal operation of your product.



WARNING: Risk of fire

Despite careful construction, electrical devices can cause fires.

- Do not install the inverter in areas containing highly flammable materials or gases.
- Do not install the inverter in potentially explosive atmospheres.

2.2 General Safety Instructions



WARNING:

Only devices in compliance with SELV (EN 69050) may be connected to the RS485 and USB interfaces.



WARNING:

Please don't connect PV array positive (+) or negative (-) to ground, it could cause serious damage to the inverter.



WARNING:

Electrical installations must be done in accordance with the local and national electrical safety standards.



WARNING:

Do not touch any inner live parts until 5 minutes after disconnection from the utility grid and the PV input.



WARNING:

To reduce the risk of fire, over-current protective devices (OCPD) are required for circuits connected to the inverter.

The DC OCPD shall be installed per local requirements. All photovoltaic source and output circuit conductors shall have isolators that comply with the NEC Article 690, Part II.



CAUTION:

Risk of electric shock, do not remove cover. There is no user serviceable parts inside, refer servicing to qualified and accredited service technicians.



CAUTION:

The PV array supplies a DC voltage when they are exposed to sunlight.



CAUTION:

The surface temperature of the inverter can reach up to 75 (167 F). To avoid risk of burns, do not touch the surface of the inverter while it's operating. Inverter must be installed out of the reach of children.



NOTE:

PV module used with inverter must have an IEC 61730 Class A rating.



WARNING:

Operations below must be accomplished by licensed technician or Beta authorized person.



WARNING:

Operator must put on the technicians' gloves during the whole process in case of any electrical hazards.



WARNING:

AC BACKUP Port of Beta Series is not allowed to connect to the grid.



WARNING:

Please refer to the specification of the battery before configuration.

2.3 Notice for Use

The inverter has been constructed according to the applicable safety and technical guidelines. Use the inverter in installations that meet the following specifications ONLY:

1. Permanent installation is required.
2. The electrical installation must meet all the applicable regulations and standards.
3. The inverter must be installed according to the instructions stated in this manual.
4. The inverter must be installed according to the correct technical specifications.

2.4 Notice for Disposal

This product shall not be disposed of with household waste. They should be segregated and brought to an appropriate collection point to enable recycling and avoid potential impacts on the environment and human health. Local rules in waste management shall be respected .

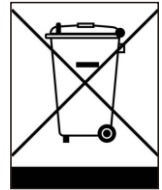



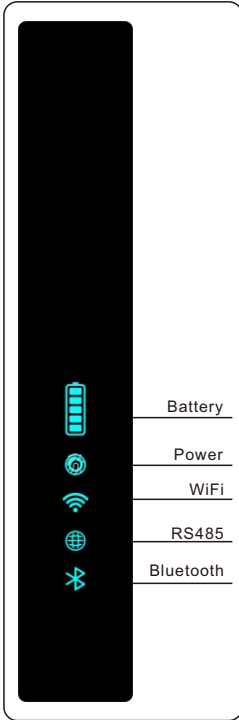

3.1 Intelligent LED Indicators

There are five indicators on the The Beta Series Inverter (Battery, Power, WiFi, Ethernet and Bluetooth) which indicate the working status of the inverter.

The Bluetooth Antenna or WiFi datalogger shall be installed at the Antenna/COM port of the hybrid inverter before local debugging.



Light	Status	Description
 Battery	Blue Flashing every 3s	Battery discharging.
	Blue Flashing every 1.5s	Battery charging.
	Blue Solid ON	Idle.
	Yellow Solid ON	Battery Warning.
 Power	Blue Solid ON	Normally Operating.
	Yellow Solid ON	Warning.
	Red Solid ON	Alarm.
 WiFi	Blue Solid ON	COM Port is using.
	OFF	COM Port is not used.
 RS485	Blue Solid ON	RS485 Port is using.
	OFF	RS485 Port is not used.
 Bluetooth	Blue Solid ON	Bluetooth Port is using.
	OFF	Bluetooth Port is not used.



NOTE:

Battery/WiFi/Ethernet/Bluetooth indicators will automatically turn off after 1 minute. The Power indicator will remain on with lower brightness. Short press the Power indicator can wake up all indicators.

4.1 Select a Location for the Inverter

To select a location for the inverter, the following criteria should be considered:

- Exposure to direct sunlight may cause output power derating. It is recommended to avoid installing the inverter in direct sunlight.
- It is recommended that the inverter is installed in a cooler ambient which doesn't exceed 104°F/40°C.

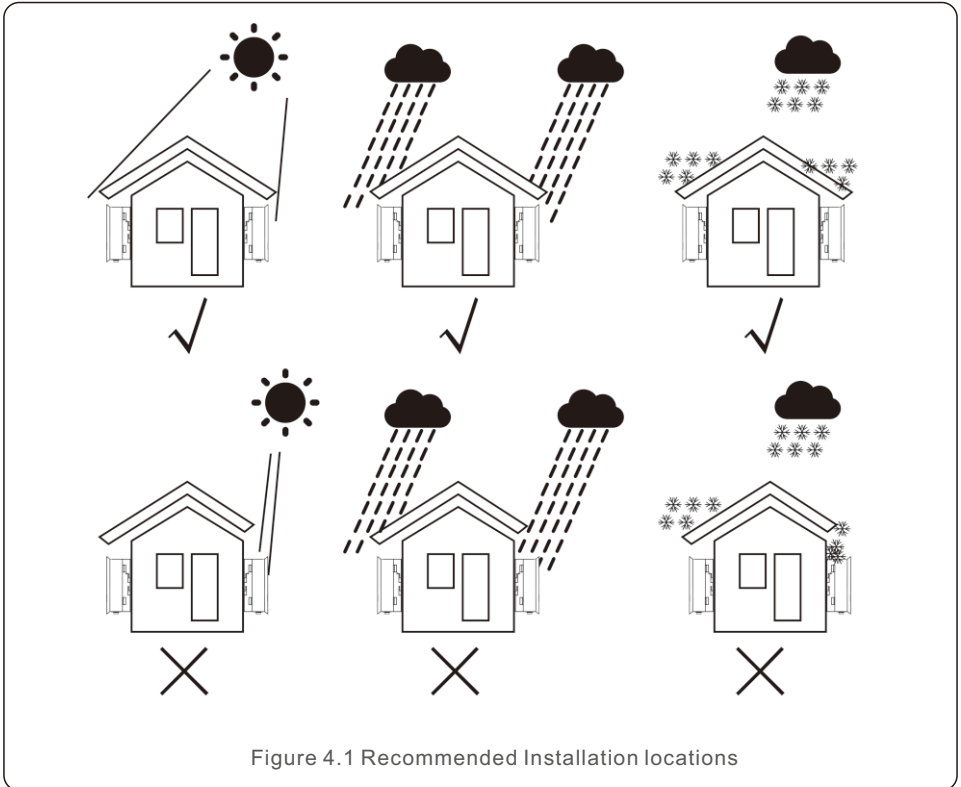

WARNING: Risk of fire



Despite careful construction, electrical devices can cause fires.

- Do not install the inverter in areas containing highly flammable materials or gases.
- Do not install the inverter in potentially explosive atmospheres.
- The mounting structure where the inverter is installed must be fireproof.

- Install on a wall or strong structure capable of bearing the weight of the machine (24kg).
- Install vertically with a maximum incline of +/- 5 degrees, exceeding this may cause output power derating.
- To avoid overheating, always make sure the flow of air around the inverter is not blocked. A minimum clearance of 500mm should be kept between inverters or objects and 1000mm clearance between the bottom of the machine and the ground.

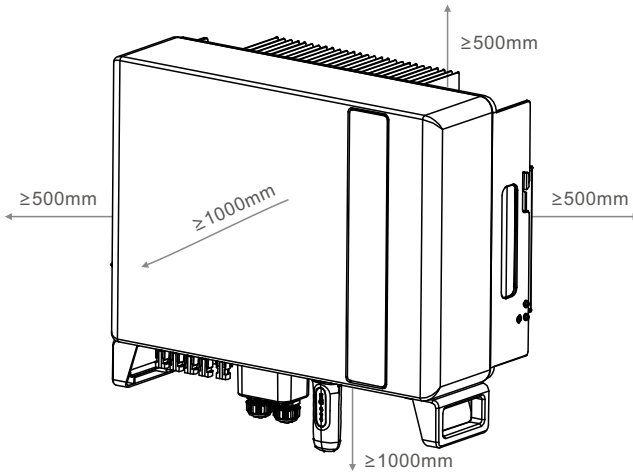

Figure 4.2 Inverter Mounting clearance

- Adequate ventilation must be provided.



NOTE:

Nothing should be stored on or placed against the inverter.

4.2 Mounting the Inverter

Dimensions of mounting bracket:

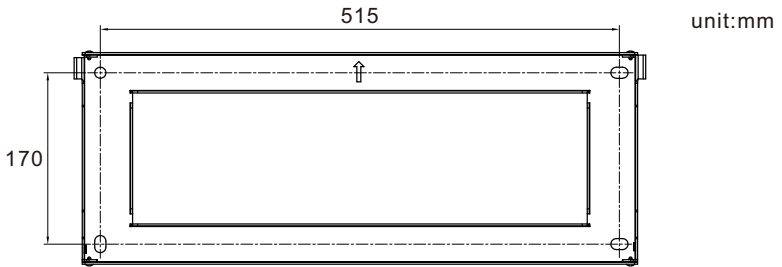

Figure 4.3 Inverter wall mounting

Once a suitable location has been found according to 4.1 using figure 4.3 mount the wall bracket to the wall.

The inverter shall be mounted vertically.

The steps to mount the inverter are listed below:

1. Select the mounting height of the bracket and mark the mounting holes.
For brick walls, the position of the holes should be suitable for the expansion bolts.
2. Lift up the inverter (be careful to avoid body strain), and align the back bracket on the inverter with the convex section of the mounting bracket. Hang the inverter on the mounting bracket and make sure the inverter is secure (see Figure 4.4)

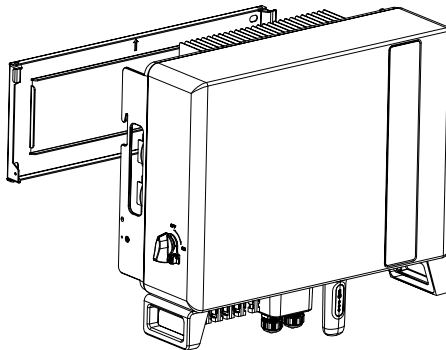

Figure 4.4 Wall Mount Bracket



WARNING:

The inverter must be mounted vertically.

4.3 PE Cable Installation

An external ground connection is provided at the right side of inverter.

Prepare OT terminals: M4. Use proper tooling to crimp the lug to the terminal.

Connect the OT terminal with ground cable to the right side of inverter. The torque is 2N.m.

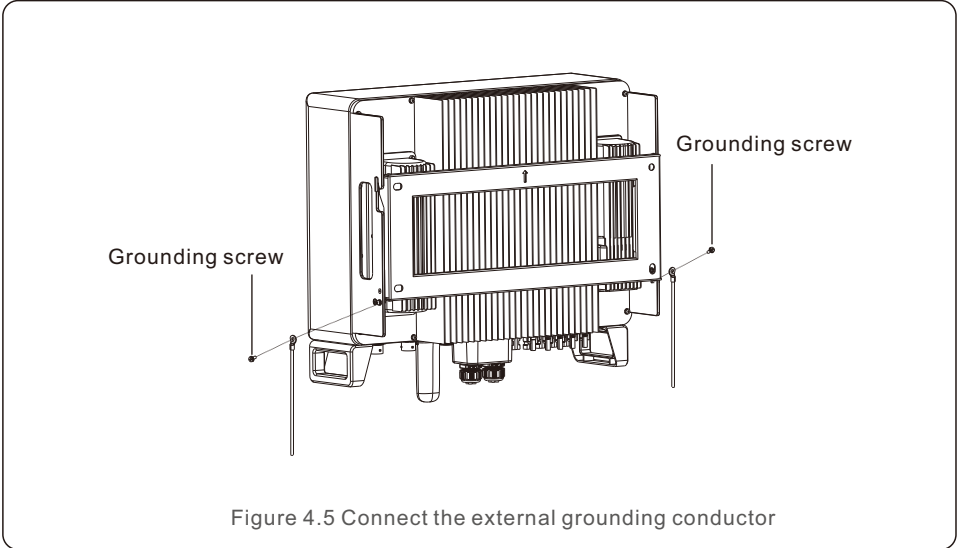

Figure 4.5 Connect the external grounding conductor

4.4 PV Input Cable Installation



Before connecting inverter, please make sure the PV array open circuit voltage is within the limit of the inverter.



Before connection, please make sure the polarity of the output voltage of PV array matches the "DC+" and "DC-" symbols.



Please use approved DC cable for PV system.

1. Select a suitable DC cable and strip the wires out by $7\pm 0.5\text{mm}$. Please refer to the table below for specific specifications.

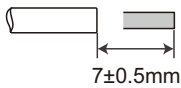

Cable type	Cross section (mm ²)	
	Range	Recommended value
Industry generic PV cable	4.0~6.0 (12~10AWG)	4.0 (12AWG)

Figure 4.6

2. Take the DC terminal out of the accessory bag, turn the screw cap to disassemble it, and take out the waterproof rubber ring.

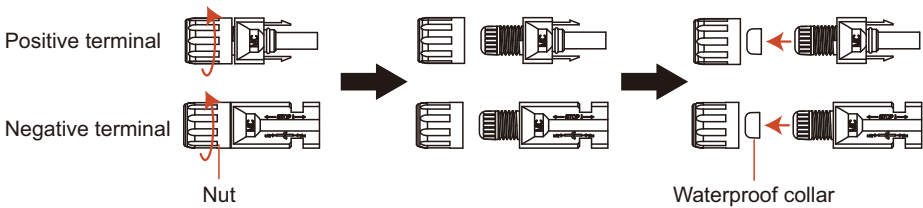
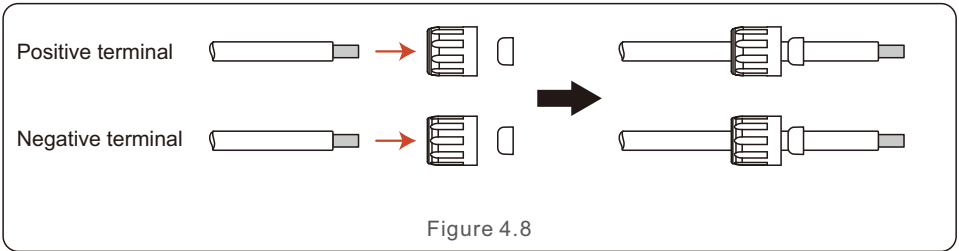
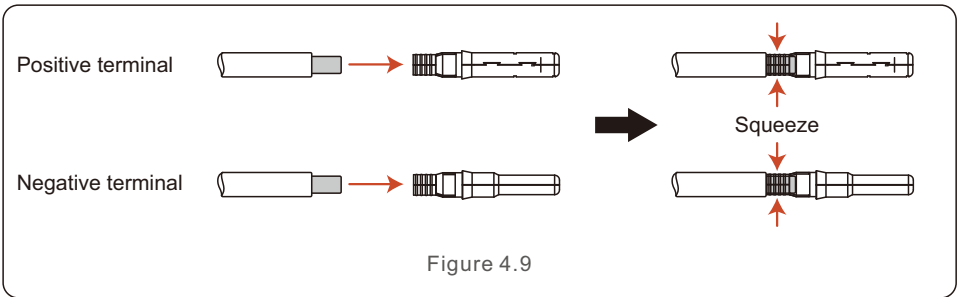

Figure 4.7

3. Pass the stripped DC cable through the nut and waterproof rubber ring.



4. Connect the wire part of the DC cable to the metal DC terminal and crimp it with a special DC terminal crimping tool.



5. Insert the crimped DC cable into the DC terminal firmly, then insert the waterproof rubber ring into the DC terminal and tighten the nut.

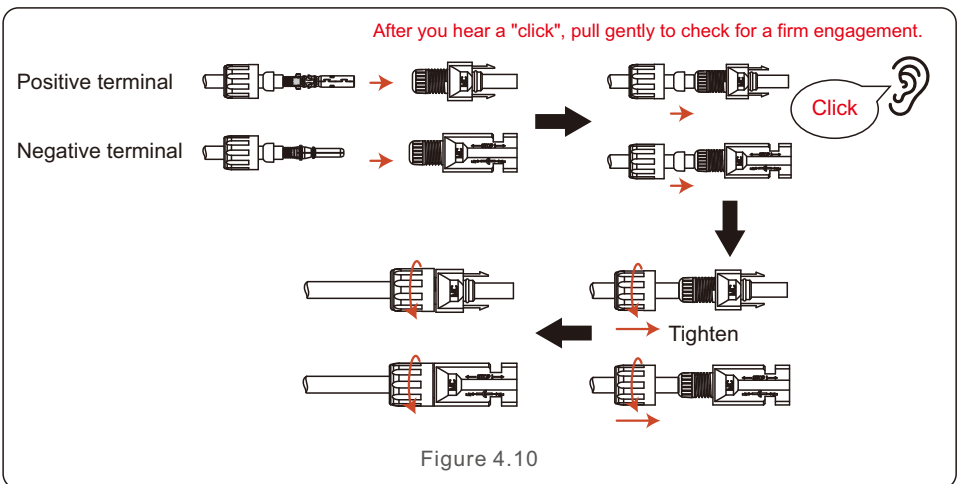

6. Measure PV voltage of DC input with multimeter, verify DC input cable polarity.

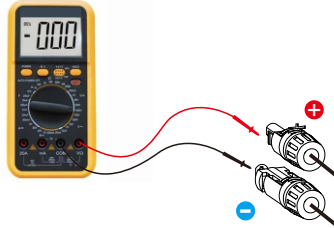

Figure 4.11

7. Connect the wired DC terminal to the inverter as shown in the figure, and a slight "click" is heard to prove the connection is correct.

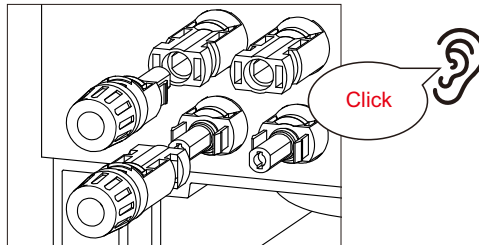

Figure 4.12



CAUTION:

If DC inputs are accidentally reversely connected or inverter is faulty or not working properly, it is NOT allowed to turn off the DC switch. Otherwise it may cause DC arc and damage the inverter or even lead to a fire disaster. The correct actions are:

- *Use a clip-on ammeter to measure the DC string current.

- *If it is above 0.5A, please wait for the solar irradiance reduces until the current decreases to below 0.5A.

- *Only after the current is below 0.5A, you are allowed to turn off the DC switches and disconnect the PV strings.

- * In order to completely eliminate the possibility of failure, please disconnect the PV strings after turning off the DC switch to avoid secondary failures due to continuous PV energy on the next day.

Please note that any damages due to wrong operations are not covered in the device warranty.

4.5 Battery Power Cable Installation

1. Take out the two pre-made battery power cables from the package.

Cable length: 1 meter.

Cross section area is 8mm².

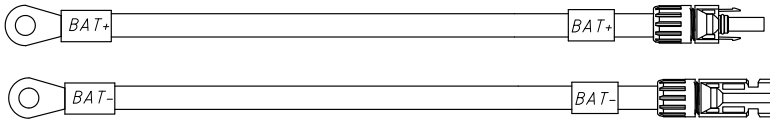

Figure 4.13

2. Connect the battery ends to the battery module positive and negative terminals.

3. Measure DC voltage of DC input with multimeter, verify DC input cable polarity.

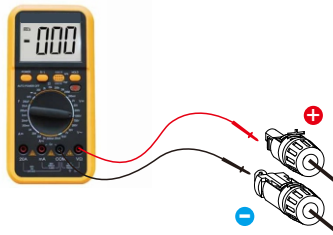

Figure 4.14

4. Connect the inverter end to the battery input port of the inverter as shown below, and push it in until you hear a "Click" sound which proves the fastened connection.

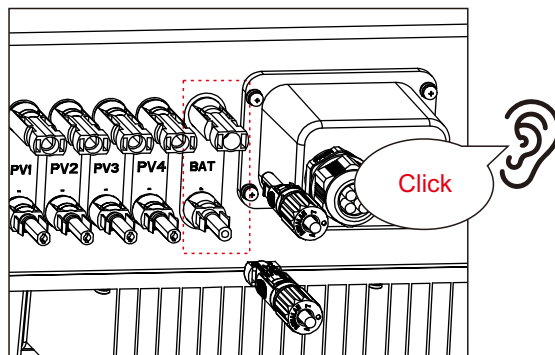

Figure 4.15

4.6 AC Cable Installation

There are two AC terminals on the inverter and the assembly steps are similar. AC Grid Port is to connect to the grid and AC Backup Port is to connect to the critical load circuit.

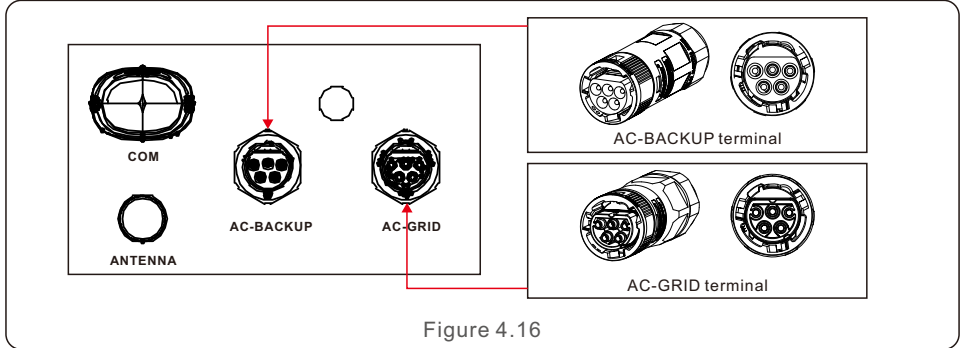

Figure 4.16



NOTE:

AC Backup Connector is longer while the AC Grid Connector is shorter.

4.6.1 AC Grid Port Connection

Describe	Numerical value
Cable diameter	14~17mm
Traverse cross sectional area	6mm ²
Exposure Length	7mm

Table 4.1

1. Strip the AC wires about 7mm.

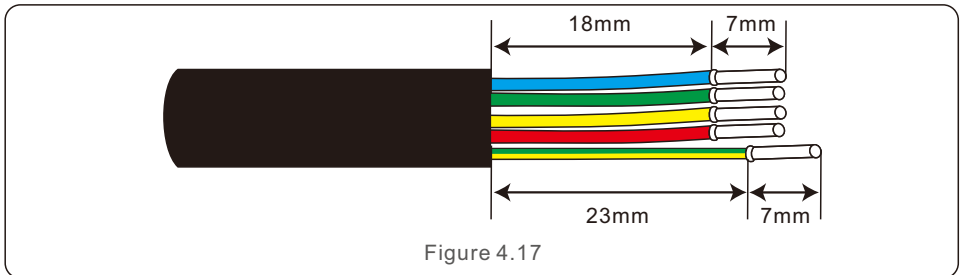

Figure 4.17

2. Disassemble the AC Grid Connector and set the parts on the cable.

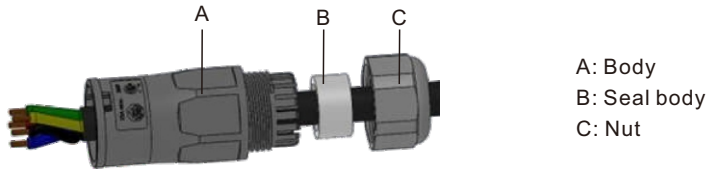

Figure 4.18

3. Crimp wires, screw torque $0.8\text{N}\cdot\text{m}\pm 0.1\text{N}\cdot\text{m}$.

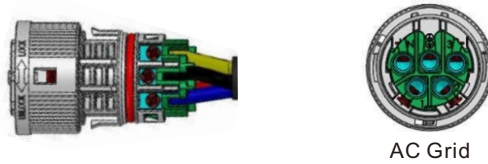

Figure 4.19

4. Push Housing into Body until you hear a "click" sound.

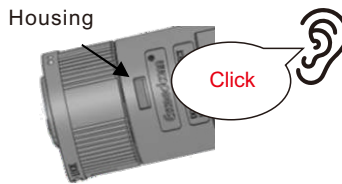

Figure 4.20

5. Insert Seal Body and Claw into the Body, and then tighten the Nut with torque $2.5\text{N}\cdot\text{m}\pm 0.5\text{N}\cdot\text{m}$.



Figure 4.21

6. Push the AC Grid Connector into the AC Grid Port on the inverter and rotate the rotatory ring on the AC Grid connector to the direction as marked "LOCK" on the connector. (Hold the Body while rotating the ring).

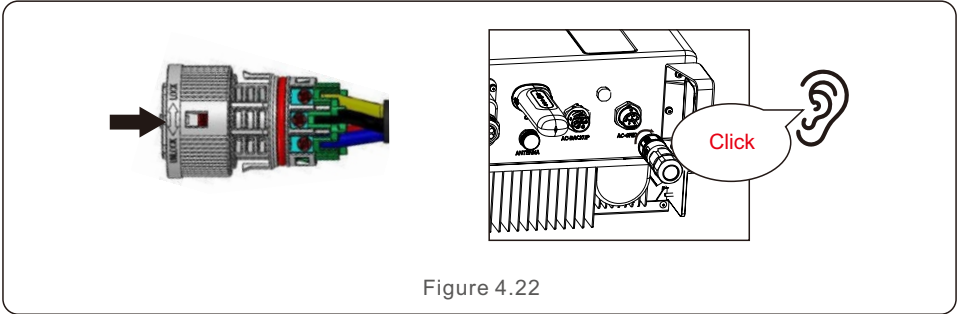

Figure 4.22



NOTE:

A continuity test shall be made to ensure that the correct terminations have been made after field wiring.

4.6.2 AC Backup Port Connection

Describe	Numerical value
Cable diameter	14~17mm
Traverse cross sectional area	6mm ²
Exposure Length	7mm

Table 4.2

1. Strip the AC wires about 7mm.

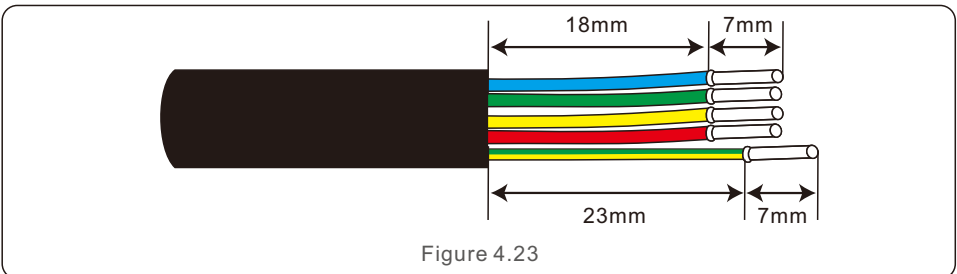
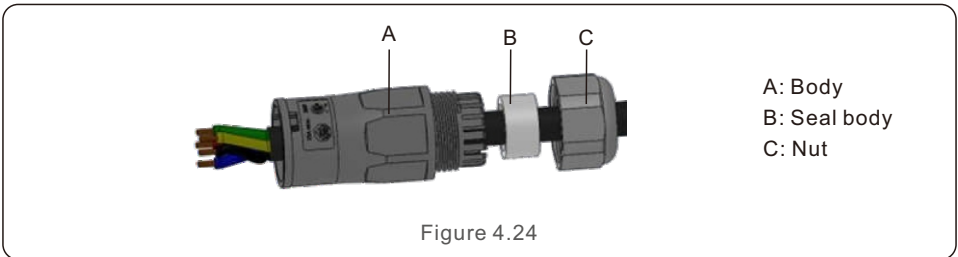
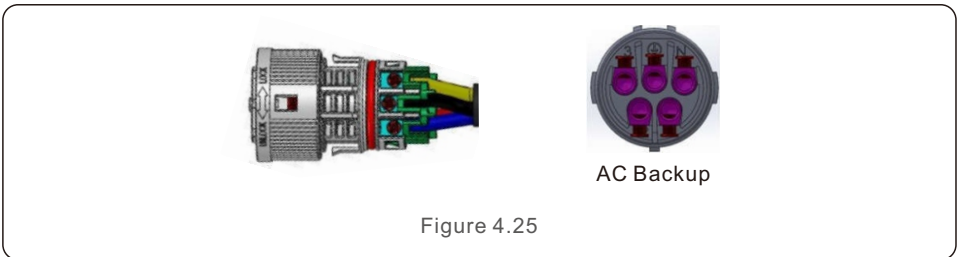

Figure 4.23

2. Disassemble the AC Backup Connector and set the parts on the cable.



3. Crimp wires, screw torque $0.8\text{N}\cdot\text{m}\pm 0.1\text{N}\cdot\text{m}$.



4. Push Housing into Body until you hear a “click” sound.

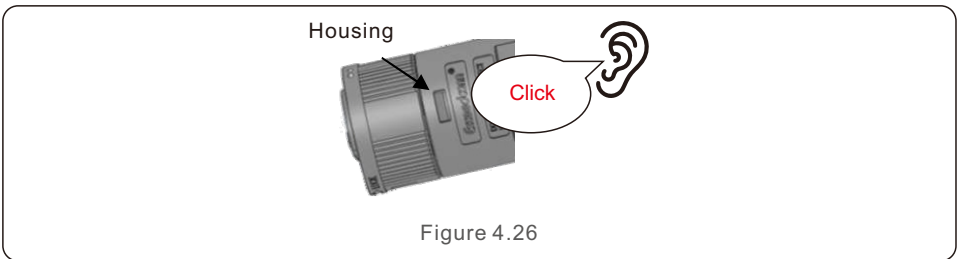

5. Insert Seal Body and Claw into the Body, and then tighten the Nut with torque $2.5\text{N}\cdot\text{m}\pm 0.5\text{N}\cdot\text{m}$.

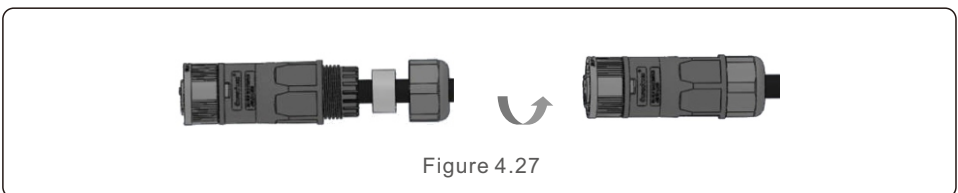

6. Push the AC Backup Connector into the AC Backup Port on the inverter and rotate the rotatory ring on the AC Backup connector to the direction as marked "LOCK" on the connector. (Hold the Body while rotating the ring).

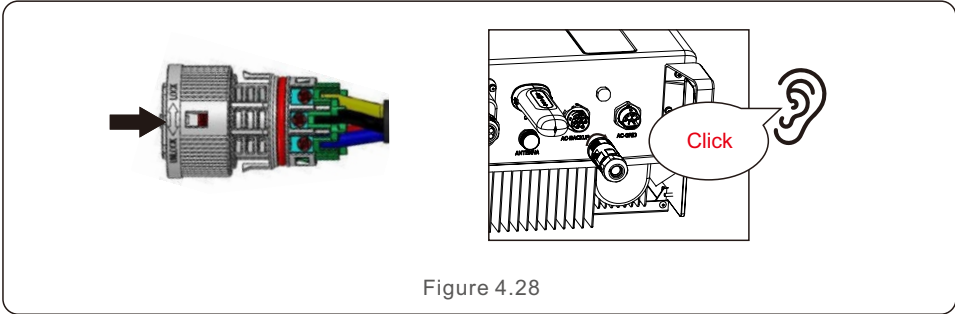

Figure 4.28



NOTE:

A continuity test shall be made to ensure that the correct terminations have been made after field wiring.

4.6.3 Disassembly Connector

1. Separate the male and female connector, rotate the locker according to the direction instructed by the marks on the locker.

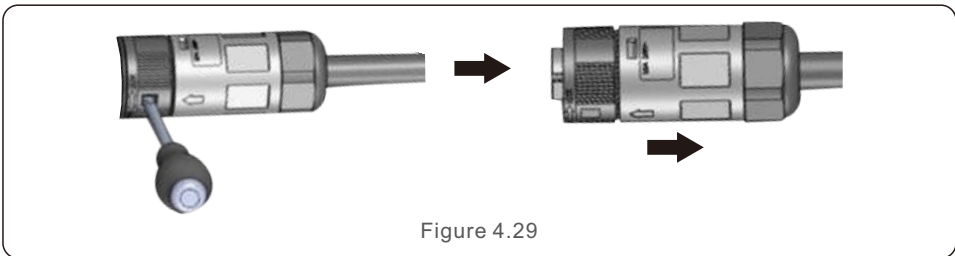

Figure 4.29

2. Disassembling body and housing for rewire.

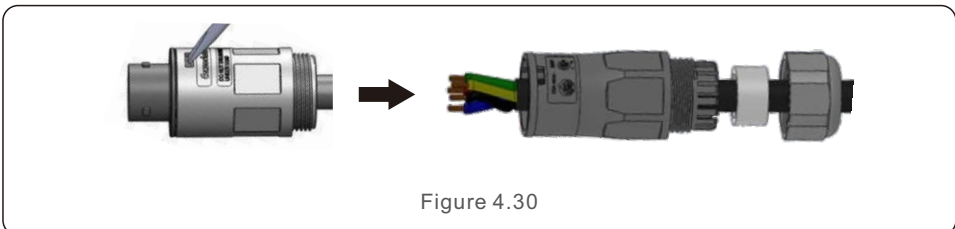

Figure 4.30

4.7 Communication Cable Installation

4.7.1 Protective Cover for Communication Ports

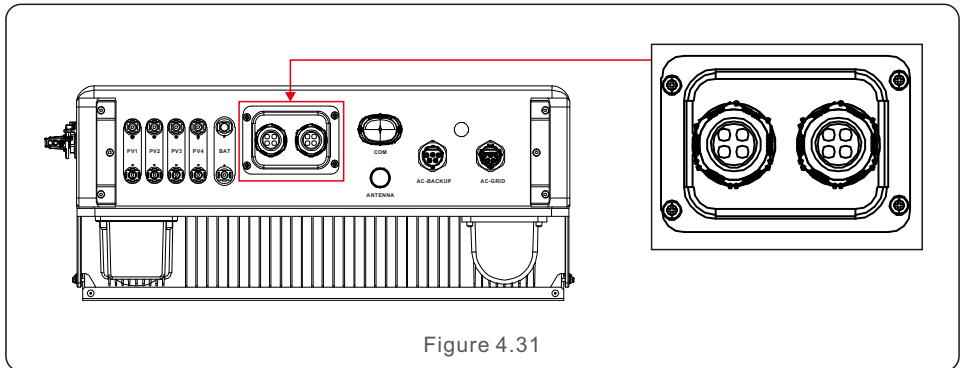

Figure 4.31

Inverter in the package is with a protective cover assembled to protect the communication ports.

Step 1. Use Phillips screwdriver to take out the 4 screws on the cover.

Step 2. Read through the following sections of the manual and prepare the internet cables correspondingly.

Step 3. Loose the cable gland and remove the watertight caps inside the cable gland based on the number of the cables and keep the unused holes with watertight cap.

Step 4. Lead the cables into the holes in the cable gland. (Hole Diameter: 6mm)

Step 5. Crimp the RJ45 connectors onto the cables according to the pin definitions described in the following sections and connect to the ports accordingly.

Step 6. Fasten the 4 screws on the cover (Torque: 1.7N.m-2 N.m)

Step 7. Reassemble the cable gland and ensure there is no bending or stretching of the internet cables inside the cover.



NOTE:

The 4-hole fastening rings inside the cable gland are with openings on the side.

Please separate the gap with hand and squeeze the cables into the holes from the side openings.

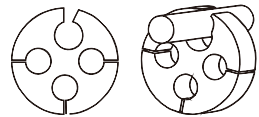

4.7.2 Communication Port Definition

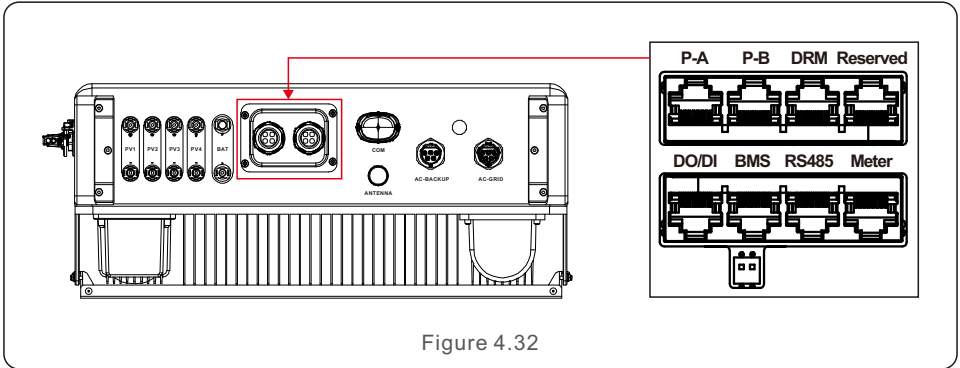

Figure 4.32

Port	Function
BMS	Used for CAN communication between inverter and Lithium battery BMS.
Meter	Used for RS485 communication between inverter and the smart meter. It is necessary to realize the normal hybrid control logics.
DRM	(Optional) To realize Demand Response or Logic interface function, this function may be required in UK and Australia.
RS485	(Optional) Used for Modbus RTU communication with 3rd party external device or controller.
P-A/P-B	(Optional) Parallel operation communication ports (Reserved).
DO/DI	(Optional) Dry contact port (Reserved).

Table 4.3

4.7.3 BMS Port Connection

Take out the pre-made CAN cable from the package and connect one end to battery CAN port and then connect another end to the inverter BMS port.

Cable Length: 3 meters.

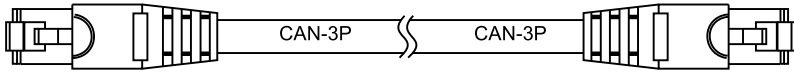
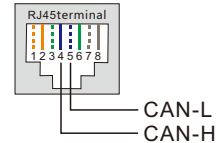

Figure 4.33



NOTE:

Pin definition of the BMS Port is following EIA/TIA 568B.
 CAN-H on Pin 4: Blue
 CAN-L on Pin 5: Blue/White



4.7.4 Meter Port Connection

Take out the pre-made Meter cable from the package and connect RJ45 end to inverter Meter port and then connect another end with loose RS485 A & B pins to the meter RS485 terminal.

Cable Length: 5 meters.

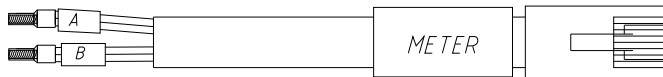
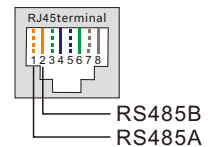

Figure 4.34



NOTE:

Pin definition of the Meter Port is following EIA/TIA 568B.
 RS485A on Pin 1: Orange/white
 RS485B on Pin 2: Orange



NOTE:

Compatible Smart Meter Pin definition.
 Eastron SDM630MCT – Pin 13 is RS485B & Pin 14 is RS485A.
 Eastron SDM630 – Pin B is RS485B & Pin A is RS485A.

4.7.5 DRM Port Connection (Optional)

4.7.5.1 For Remote Shutdown Function

Beta inverters support remote shutdown function to remotely control the inverter to power on and off through logic signals.

The DRM port is provided with an RJ45 terminal and its Pin5 and Pin6 can be used for remote shutdown function.

Signal	Function
Short Pin5 and Pin6	Inverter Generates
Open Pin5 and Pin6	Inverter Shutdown in 5s

Table 4.4

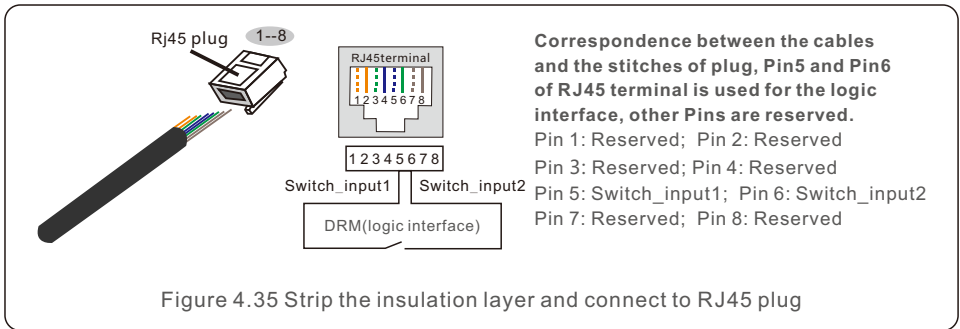

Figure 4.35 Strip the insulation layer and connect to RJ45 plug

4.7.5.2 For DRED Control Function (For AU and NZ Only)

DRED means demand response enable device. The AS/NZS 4777.2:2020 required inverter need to support demand response mode(DRM).

This function is for inverter that comply with AS/NZS 4777.2:2020 standard.

A RJ45 terminal is used for DRM connection.

Pin	Assignment for inverters capable of both charging and discharging	Pin	Assignment for inverters capable of both charging and discharging
1	DRM 1/5	5	RefGen
2	DRM 2/6	6	Com/DRM0
3	DRM 3/7	7	V+
4	DRM 4/8	8	V-

Table 4.5



NOTE:

Beta hybrid inverter is designed to provide 12V power for DRED.

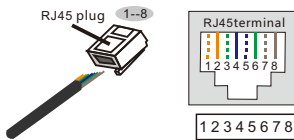

Correspondence between the cables and the stitches of plug

- Pin 1: white and orange ; Pin 2: orange
- Pin 3: white and green; Pin 4: blue
- Pin 5: white and blue; Pin 6: green
- Pin 7: white and brown; Pin 8: brown

Figure 4.36 Strip the insulation layer and connect to RJ45 plug

4.7.6 RS485 Port Connection (Optional)

If a 3rd party external device or controller needs to communicate with the inverter, the RS485 port can be used. Modbus RTU protocol is supported by Beta inverters.

To acquire latest protocol document, please contact Beta local service team or Beta sales.



NOTE:

Pin definition of the RS485 Port is following

EIA/TIA 568B.

RS485A on Pin 5: Blue/White

RS485B on Pin 4: Blue

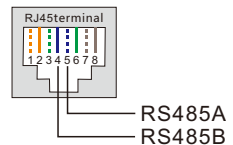

4.8 Meter Installation



CAUTION:

Make sure the AC cable is totally isolated from AC power before connecting the Smart Meter and CT.

The Beta S6-EH3P(3-10)K-H Series inverter is able to connected standard Eastron meters to fulfill the control logic of the self-consumption mode, export power control, monitoring, etc.

Eastron 3ph meter (With CT): SDM630MCT (Provided by default)

Eastron 3ph meter (Direct Insert): SDM630 (Optional, Customer prepare if needed)



NOTE:

Please note that the CT orientation must be correct, otherwise the system will not work properly.



Compatible Smart Meter Model	Meter RS485 Pin Definition
SDM630MCT	Pin 13 – RS485B, Pin 14 – RS485A
SDM630	B – RS485B, A – RS485A

Table 4.6

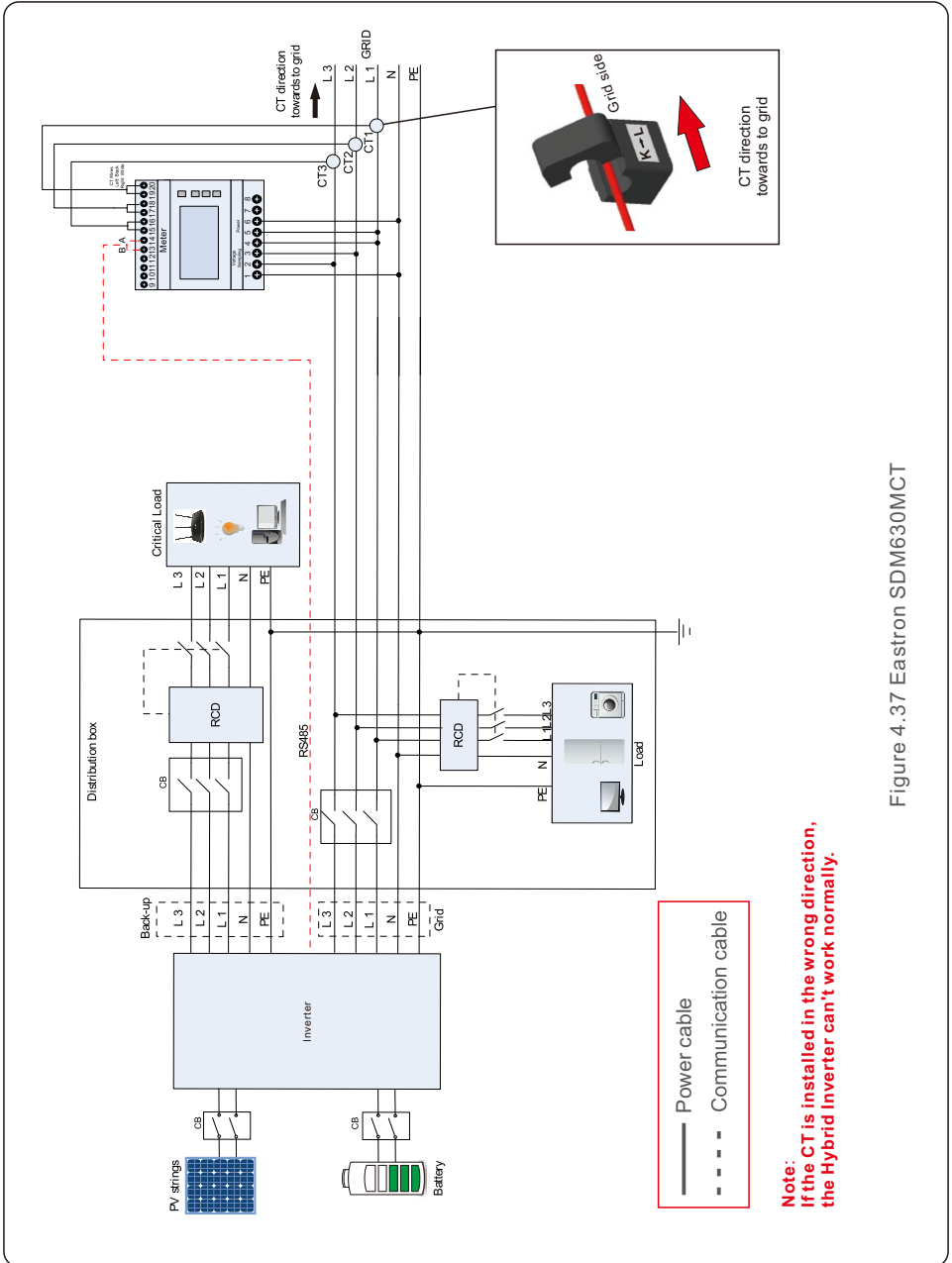

Figure 4.37 Eastron SDM630MCT

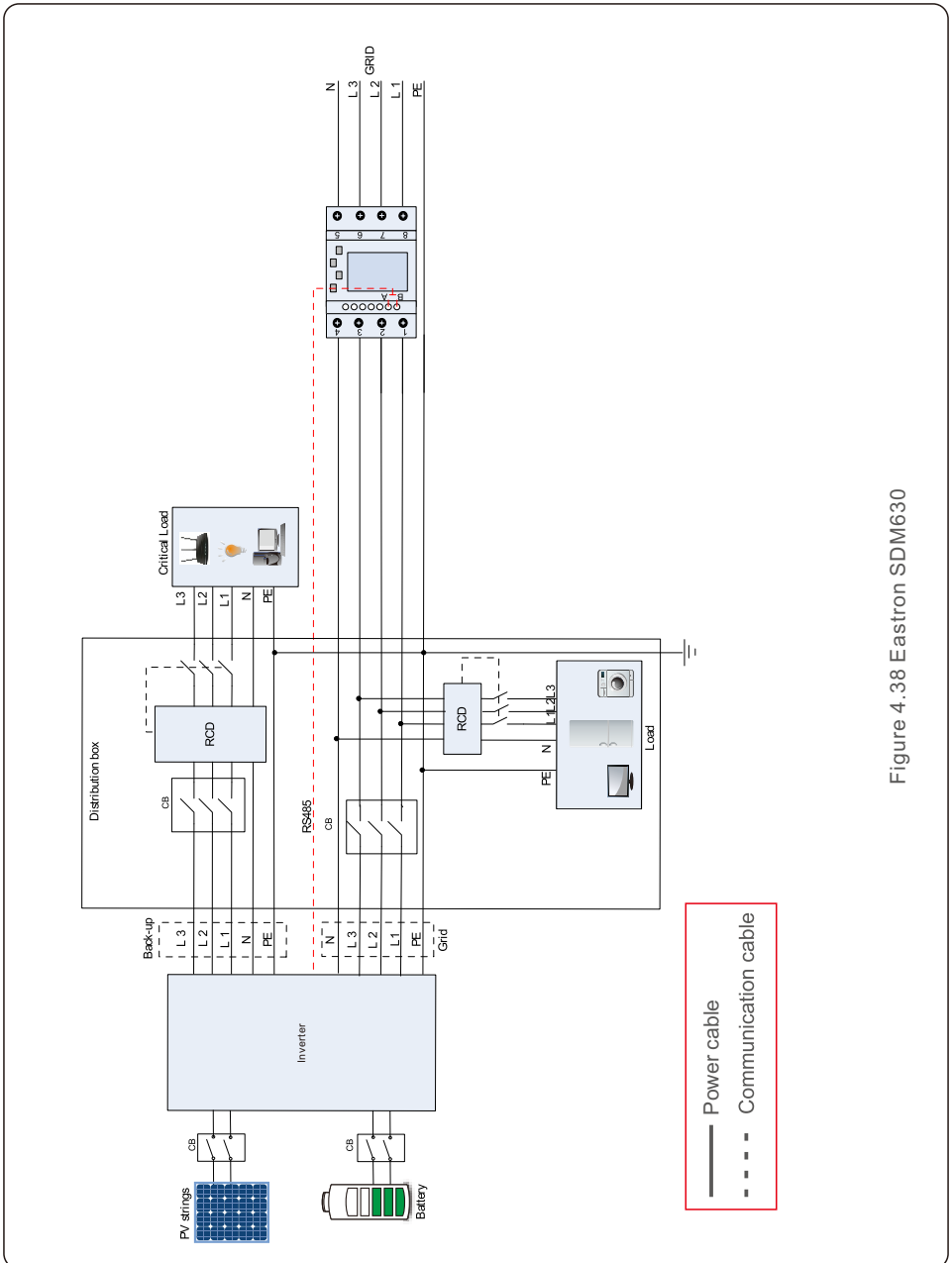

Figure 4.38 Eastron SDM630

4.9 Inverter Remote Monitoring Connection

The inverter can be remotely monitored via WiFi, LAN or 4G.

The USB type COM port at the bottom of the inverter can connect to different kinds of solis data loggers to realize the remote monitoring on Soliscloud platform.

To install solis data loggers, please refer to corresponding user manuals of solis data loggers.

The solis data loggers are optional and can be purchased separately.

Dust cover is provided the inverter package in case the port is not used.



WARNING:

The USB type COM port is only allowed to connect solis data loggers. It is forbidden to be used for other purposes.

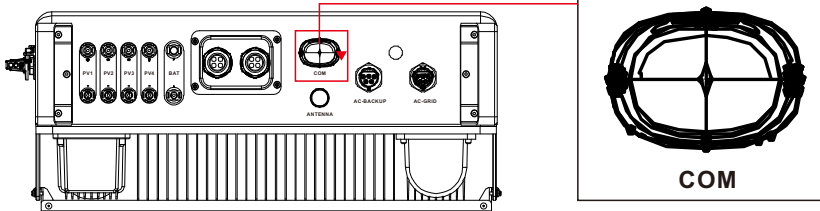

Figure 4.39

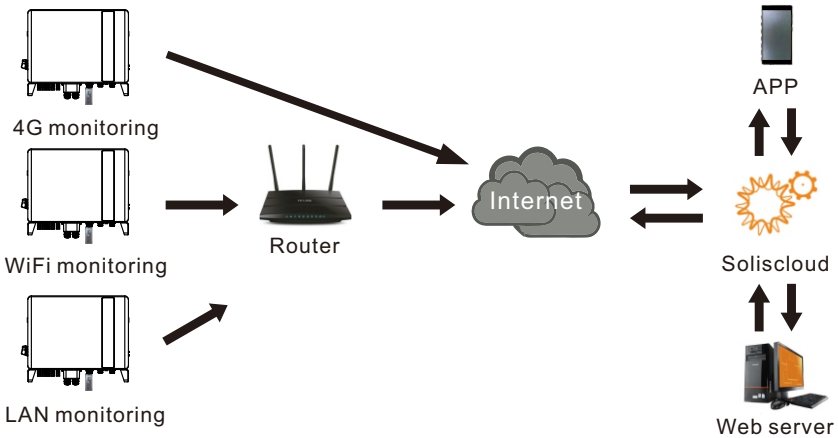

Figure 4.40 Wireless communication function

5.1 Preparation of Commissioning

- Ensure all the devices are accessible for operation, maintenance and service.
- Check and confirm that the inverter is firmly installed.
- Space for ventilation is sufficient for one inverter or multiple inverters.
- Nothing is left on the top of the inverter or battery module.
- Inverter and accessories are correctly connected.
- Cables are routed in safe place or protected against mechanical damage.
- Warning signs and labels are suitably affixed and durable.
- Bluetooth Antenna has been connected to the Antenna port of the inverter.
- An Android or IOS mobile phone with Bluetooth function is available.
- Soliscloud APP is installed on the mobile phone.

There are three ways to download and install the latest APP:

1. You can visit www.Soliscloud.com to download the latest version APP.
2. You can search “**Soliscloud**” in Google Play or App Store.
3. You can scan this QR code below to download “**Soliscloud**”.



5.2 Commissioning Procedure

Step 1: Measure DC voltage of PV strings and battery and ensure the polarity is correct.

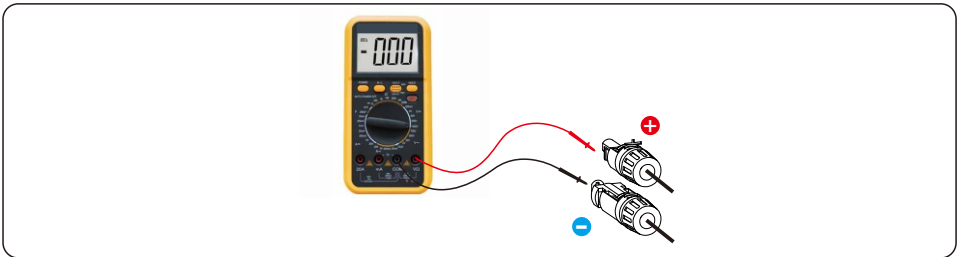

Step 2: Measure AC voltage and frequency and ensure they are within local standard.

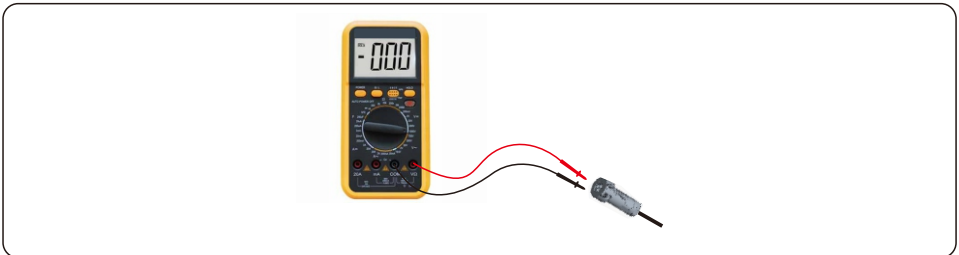

Step 3: Switch on the external AC breaker to power on the inverter control board.
(Bluetooth signal available)

Step 4: **Connect with Bluetooth.**

Turn on Bluetooth switch on your mobile phone and then open the Soliscloud APP.
Click “More Tools”->”Local Operation”->”Connect with Bluetooth”

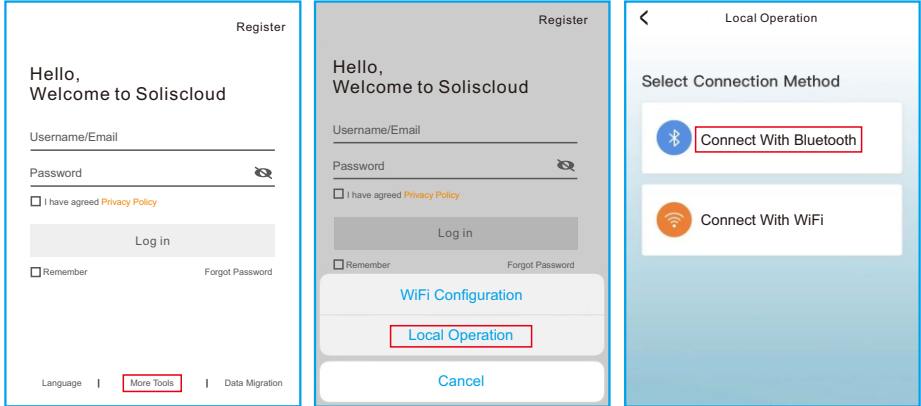

Step 5: Select the Bluetooth signal from the inverter. (Bluetooth Name: Inverter SN)

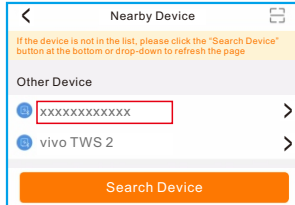

Step 6: **Login account.**

If you are the installer, please select the account type as Installer. If you are the plant owner, please select the account type as owner. Then set your own initial password for control verification. (The first log-in must be finished by installer in order to do the initial set up)

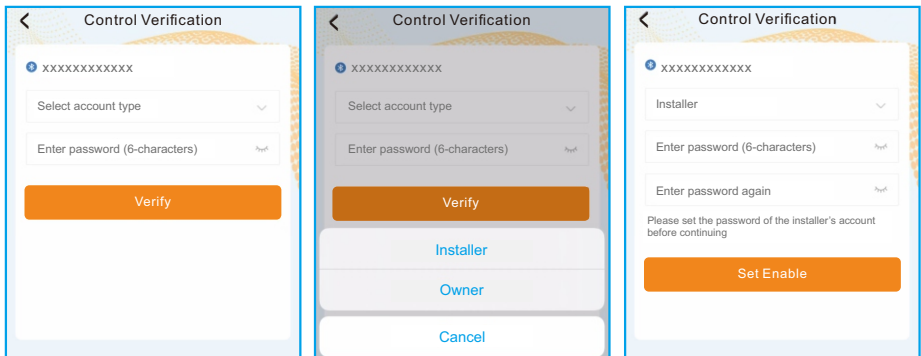

Step 7: After the log in for the first time, initial settings are required.

Step 7.1: Set the inverter Date and Time.

You can set to follow the time on your mobile phone.

Step 7.2: Set the battery model.

It must be based on the battery model that is actually connected to the inverter.

If there is no battery connected for the moment, please select “No Battery” to avoid alarms.

The default setting for battery over discharge SOC is 20%, force charge SOC is 10%.

Step 7.3: Set the meter setting.

It must be based on the meter type that is actually connected to the inverter.

If there is no meter connected for the moment, please select “No Meter” to avoid alarms.

It is suggested to install the meter at the system grid connection point and select “Meter in Grid”.

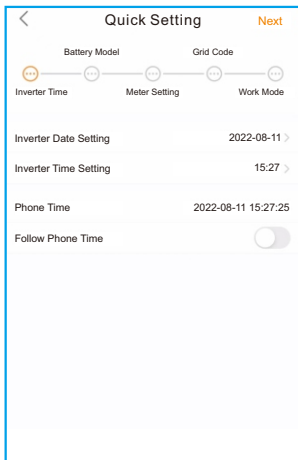

Step 7.1

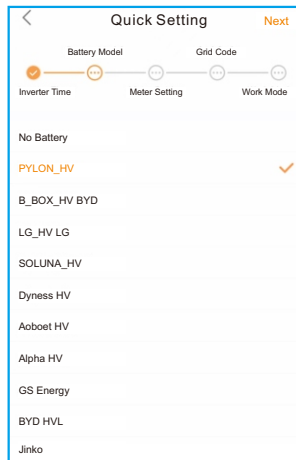

Step 7.2

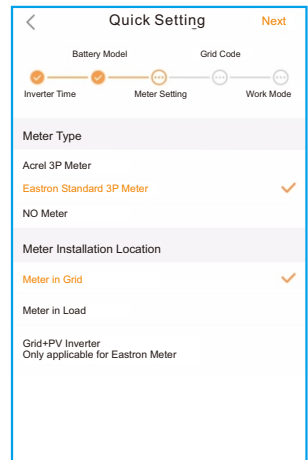

Step 7.3

Step 7.4: Set the grid code setting.

Please select the grid code based on the local grid network requirements.

Step 7.5: Set the work mode setting.

Recommended setting is Self-Use Mode. This mode can maximize the use of PV power generation for household electricity, or store it in batteries and use it for household electricity. If need manually control the battery charging and discharging with respect to time, please use the Time of Use switch and the following set points. The “Allow Grid Charging” is recommended to be turned on (If turned off, the inverter will not force charge the battery and battery could potentially go to sleep).

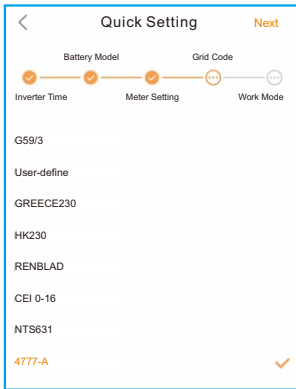

Step 7.4

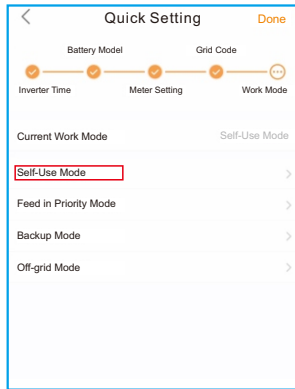

Step 7.5(1)

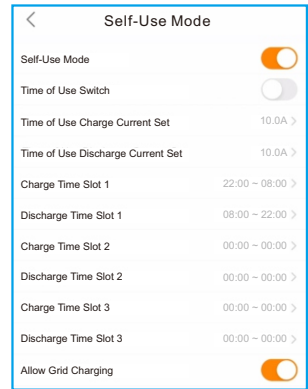

Step 7.5(2)

Step 8: Setup complete.

Now the initial settings on the inverter have been set and you can switch on the inverter DC switch and switch on battery breaker to start up the system. You can also explore in the APP to check the operating data, alarm message or other advanced settings.

Step 9: Change Password.

If the Owner forgot the password, please contact the installer. Installer log in and go to "Setting"->"More"->"Change Password" to reset the password for owner's account.

If Installer forgot the password, please contact Beta service team.

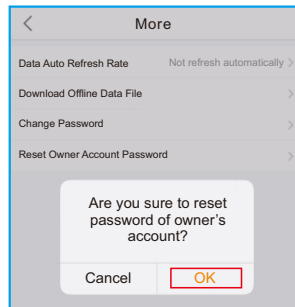
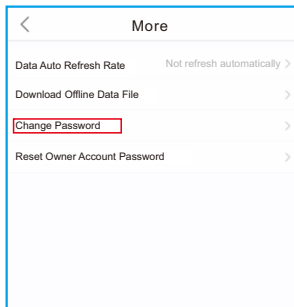

5.3 Shutdown procedure

Step 1. Turn off the AC breaker at the grid connection point.

Step 2. Turn off the DC switch of the inverter.

Step 3. Turn off the battery breaker.

Step 4. Waiting for the device powered off and the system shutdown is completed.

Beta Series inverter does not require any regular maintenance. However, cleaning the heatsink will help inverter dissipating heat and increase the lifetime of inverter. The dirt on the inverter can be cleaned with a soft brush.



CAUTION:

Do not touch the surface when the inverter is operating. Some parts may be hot and cause burns. Turn OFF the inverter and let it cool down before you do any maintenance or cleaning of inverter.

The Screen and the LED status indicator lights can be cleaned with cloth if they are too dirty to be read.



NOTE:

Never use any solvents, abrasives or corrosive materials to clean the inverter.

Message Name	Information Description	Troubleshooting Suggestion
Off	Control device to shutdown	1. Turn on the device in the ON/OFF Setting.
LmtByEPM	The device's output is under controlled	<ol style="list-style-type: none"> 1. Confirm whether the inverter is connected to an external EPM/meter to prevent reverse current. 2. Confirm whether the inverter is controlled by an external third-party device. 3. Confirm whether the power setting of the inverter power control is limited. 4. Verify settings in section 6.6.7 and check your meter readings.
LmtByDRM	DRM Function ON	1. No need to deal with it.
LmtByTemp	Over temperature power limited	1. No need to deal with it, the device is in normal operation.
LmtByFreq	Frequency power limited	
LmtByVg	The device is in the Volt-Watt mode	<ol style="list-style-type: none"> 1. Due to the requirements of local safety regulations, when the grid voltage is high, the Volt-watt working mode is triggered, which generally does not need to be dealt with. 2. Inverter factory test errors causing this mode to open, if you need to close, you can close this mode in LCD, set the process: Main menu → Advanced Settings → Password 0010 → STD mode settings → Working Mode → Working mode: NULL → Save and exit.
LmtByVar	The device is in the Volt-Var mode of operation	<ol style="list-style-type: none"> 1. Due to the requirements of local safety regulations, when the grid voltage is high, the Volt-watt working mode is triggered, which generally does not need to be dealt with. 2. Inverter factory test errors causing this mode to open, if you need to close, you can close this mode in LCD, set the process: Main menu → Advanced Settings → Password 0010 → STD mode settings → Working Mode → Working mode: NULL → Save and exit.
LmtByUnFr	Under frequency limit	1. No need to deal with it.
Standby	Bypass run	
StandbySynoch	Off grid status to On grid status	
GridToLoad	Grid to load	

Message Name	Information Description	Troubleshooting Suggestion
Surge Alarm	On-site grid surge	1. Grid side fault, restart the device. If it is still not eliminated, please contact the manufacturer's customer service.
OV-G-V01	Grid voltage exceeds the upper voltage range	1. Confirm whether the power grid is abnormal. 2. Confirm that the AC cable is properly connected. 3. Restart the system and check if the fault persists.
UN-G-V01	Grid voltage exceeds the lower voltage range	
OV-G-F01	Grid frequency exceeds the upper frequency range	
UN-G-F01	Grid frequency exceeds the lower frequency range	
G-PHASE	Unbalanced grid voltage	
G-F-GLU	Grid voltage frequency fluctuation	
NO-Grid	No grid	
OV-G-V02	Grid transient overvoltage	
OV-G-V03	Grid transient overvoltage	1. Restart the system, confirm if that the fault continues.
IGFOL-F	Grid current tracking failure	1. Confirm whether the power grid is abnormal. 2. Confirm that the AC cable is properly connected. 3. Restart the system and check if the fault persists.
OV-G-V05	Grid voltage RMS instantaneous overvoltage fault	
OV-G-V04	Grid voltage exceeds the upper voltage range	
UN-G-V02	Grid voltage exceeds the lower voltage range	
OV-G-F02	Grid frequency exceeds the upper frequency range	
UN-G-F02	Grid frequency exceeds the lower frequency range	
NO-Battery	Battery is not connected	1. Check on information page 1 – Verify the battery voltage is within standards. 2. Measure battery voltage at plug.
OV-Vbackup	Inverting overvoltage	1. Check whether the backup port wiring is normal 2. Restart the system, confirm that the fault continues.
Over-Load	Load overload fault	1. Backup load power is too large, or some inductive load startup power is too large, need to remove some backup load, or remove the inductive load on the backup.

Message Name	Information Description	Troubleshooting Suggestion
BatName-FAIL	Wrong battery brand selection	1. Confirm whether the battery model selection is consistent with the actual one.
CAN Fail	CAN Fail	1. Can failure is a failure of communication between inverter and battery. Check cable conditions. Check to ensure you have it plugged in on the CAN port of the battery and inverter. Check that you are using the right cable. Some batteries require a special battery from the battery manufacturer.
OV-Vbatt	Battery undervoltage detected	1. Verify battery voltage is within standards. Measure battery voltage at inverter connection point. Contact your battery manufacturer for further service.
UN-Vbatt	Battery overvoltage detected	1. Restart the system and check if the fault persists. If it is still not eliminated, please contact the manufacturer's customer service.
Fan Alarm	Fan alarm	1. Check if the internal fan is working correctly or jammed.
OV-DC01 (1020 DATA:0001)	DC 1 input overvoltage	1. Check if the PV voltage is abnormal 2. Restart the system, confirm that the fault continues
OV-DC02 (1020 DATA:0002)	DC 2 input overvoltage	
OV-BUS (1021 DATA:0000)	DC bus overvoltage	1. Restart the system, confirm that the fault continues.
UN-BUS01 (1023 DATA:0001)	DC bus undervoltage	
UNB-BUS (1022 DATA:0000)	DC bus unbalanced voltage	
UN-BUS02 (1023 DATA:0002)	Abnormal detection of DC bus voltage	
DC-INTF. (1027 DATA:0000)	DC hardware overcurrent (1, 2, 3, 4)	1. Check if the DC wires are connected correctly without loose connection.
OV-G-I (1018 DATA:0000)	Aphase RMS value overcurrent	1. Confirm that the grid is abnormal. 2. Confirm that the AC cable connection is not abnormal. 3. Restart the system, confirm that the fault continues.
OV-DCA-I (1025 DATA:0000)	DC 1 average overcurrent	1. Restart the system, confirm that the fault continues.
OV-DCB-I (1026 DATA:0000)	DC 2 average overcurrent	
GRID-INTF. (1030 DATA:0000)	AC hardware overcurrent (abc phase)	

Message Name	Information Description	Troubleshooting Suggestion
DCInj-FAULT (1037 DATA:0000)	The current DC component exceeds the limit	<ol style="list-style-type: none"> 1. Confirm that the grid is abnormal. 2. Confirm that the AC cable connection is not abnormal. 3. Restart the system, confirm that the fault continues.
IGBT-OV-I (1048 DATA:0000)	IGBT overcurrent	<ol style="list-style-type: none"> 1. Restart the system, confirm that the fault continues.
OV-TEM (1032 DATA:0000)	Module over temperature	<ol style="list-style-type: none"> 1. Check whether the surrounding environment of the inverter has poor heat dissipation. 2. Confirm whether the product installation meets the requirements.
RelayChk-FAIL (1035 DATA:0000)	Relay failure	<ol style="list-style-type: none"> 1. Restart the system, confirm that the fault continues.
UN-TEM (103A DATA:0000)	Low temperature protection	<ol style="list-style-type: none"> 1. Check the working environment temperature of the inverter. 2. Restart the system to confirm if the fault continues.
PV ISO-PRO01 (1033 DATA:0001)	PV negative ground fault	<ol style="list-style-type: none"> 1. Check whether the PV strings have insulation problems. 2. Check whether the PV cable is damaged.
PV ISO-PRO02 (1033 DATA:0002)	PV positive ground fault	
12Power-FAULT (1038 DATA:0000)	12V undervoltage failure	<ol style="list-style-type: none"> 1. Check current leakage to ground. Verify your grounding. Verify all wires are in good condition and not leaking current to ground.
ILeak-PRO01 (1034 DATA:0001)	Leakage current failure 01 (30mA)	
ILeak-PRO02 (1034 DATA:0002)	Leakage current failure 02 (60mA)	
ILeak-PRO03 (1034 DATA:0003)	Leakage current failure 03 (150mA)	
ILeak-PRO04 (1034 DATA:0004)	Leakage current failure 04	
ILeak_Check (1039 DATA:0000)	Leakage current sensor failure	
GRID-INTF02 (1046 DATA:0000)	Power grid disturbance 02	<ol style="list-style-type: none"> 1. Confirm whether the grid is seriously distorted. 2. Check whether the AC cable is connected reliably.
OV-Vbatt-H/ OV-BUS-H (1051 DATA:0000)	Battery overvoltage hardware failure / VBUS	<ol style="list-style-type: none"> 1. Check if the battery circuit breaker is tripping. 2. Check if the battery is damaged.

Message Name	Information Description	Troubleshooting Suggestion
OV-ILLC (1052 DATA:0000)	LLC hardware overcurrent	1. Check whether the backup load is overloaded. 2. Restart the system, confirm that the fault continues.
INI-FAULT (1031 DATA:0000)	AD zero drift overlink	1. Restart the system, confirm that the fault continues.
DSP-B-FAULT (1036 DATA:0000)	The master-slave DSP communication is abnormal	
AFCI-Check (1040 DATA:0000)	AFCI self-test failure	
ARC- FAULT (1041 DATA:0000)	AFCI failure	1. Verify connections are tight within your PV system. Arc fault settings can be changed in advanced settings if further adjustment is necessary.

Table 7.1 Fault message and description



NOTE:

If the inverter displays any alarm message as listed in Table 7.1; please turn off the inverter and wait for 5 minutes before restarting it .
If the failure persists, please contact your local distributor or the service center.

Please keep ready with you the following information before contacting us.

1. Serial number of Beta Three Phase Inverter;
2. The distributor/dealer of Beta Three Phase Inverter (if available);
3. Installation date.
4. The description of the problem together with necessary information, pictures, attachment.
5. The PV array configuration (e.g. number of panels, capacity of panels, number of strings, etc.);
6. Your contact details.

8. Specifications

Technical Data	MF-BETA-RHI3P5KV2	MF-BETA-RHI3P6KV2
Input DC (PV side)		
Recommended max. PV power	8000W	9600W
Max. input voltage	1000V	
Rated voltage	600V	
Start-up voltage	160V	
MPPT voltage range	200-850V	
Full load MPPT voltage range	200-850V	
Max. input current	16A/16A/16A	
Max. short circuit current	24A/24A/24A	
MPPT number/Max input strings number	3/3	
Battery		
Battery Type	Li-ion	
Battery Voltage range	120 - 600Vdc	
Maximum charging Power	5kW	6kW
Maximum Charge/discharge current	25A	
Communication	CAN/RS485	
Output AC(Grid-side)		
Rated output power	5kW	6kW
Max. apparent output power	5.5kVA	6.6kVA
Rated grid voltage	3/N/PE, 380V/400V	
The grid voltage range	320-460V	
Rating grid frequency	50 Hz/60 Hz	
AC grid frequency range	45-55 Hz/ 55-65Hz	
Rating grid output current	7.6A/7.2A	9.1A/8.7A
Max. output current	8.4A/7.9A	10.0A/9.6A
Power factor	> 0.99 (0.8 leading to 0.8 lagging)	
THDi	< 3%	

8. Specifications

Technical Data	MF-BETA-RHI3P5KV2	MF-BETA-RHI3P6KV2
Input AC(Grid-side)		
Max. input power	7.5kW	9kW
Rated input current	11.4A	13.8A
Rated input voltage	3/N/PE, 380V/400V	
Rated input frequency	50 Hz/60 Hz	
Output AC(Back-up)		
Rated output power	5kW	6kW
Peak apparent output power	8.0kVA, 60 sec	9.6kVA, 60 sec
Back-up switch time	< 10ms	
Rated output voltage	3/N/PE, 380V/400V	
Rated frequency	50 Hz/60 Hz	
Rated output current	7.6A/7.2A	9.1A/8.7A
THDv(@linear load)	<2%	
Efficiency		
PV Max. efficiency	97.87%	97.91%
EU efficiency	96.77%	97.10%
BAT charged by PV Max. efficiency	98.37%	98.45%
BAT charged/discharged to AC Max. efficiency	97.32%	97.34%
Protection		
Anti-islanding protection	Yes	
AFCI	Yes	
Insulation Resistor detection	Yes	
Residual current monitoring unit	Yes	
Output over current protection	Yes	
Output short protection	Yes	
Output over voltage protection	Yes	
DC switch	Yes	
DC reverse polarity protection	Yes	
PV overvoltage protection	Yes	
Battery reverse protection	Yes	

8. Specifications

Technical Data	MF-BETA-RHI3P5KV2	MF-BETA-RHI3P6KV2
General data		
Dimensions(W/H/D)	600*500*230mm	
Weight	32.6kg	
Topology	Transformerless	
Self consumption (Night)	<25 W	
Operation temperature range	-25°C ~ +60°C	
Relative humidity	0-95%	
Ingress protection	IP66	
Cooling concept	Natural convection	
Max.operation altitude	4000m	
Grid connection standard	G98 or G99, VDE-AR-N 4105 / VDE V 0124, EN 50549-1, VDE 0126 / UTE C 15/VFR:2019, RD 1699/RD 244 / UNE 206006 / UNE 206007-1, CEI 0-21, C10/11, NRS 097-2-1, TOR, EIFS 2018.2, IEC 62116, IEC 61727, IEC 60068, IEC 61683, EN 50530, MEA, PEA	
Safety/EMC standard	IEC 62109-1/-2 ,EN 61000-6-1/-3	
Features		
PV connection	MC4 connector	
Battery connection	Quick Connection plug	
AC connection	Quick Connection plug	
Display	LED + Bluetooth + APP	
Communication	CAN, RS485, Ethernet, Optional:Wi-Fi, Cellular, LAN	
Warranty	5 years (extend to 20 years)	

8. Specifications

Technical Data	MF-BETA-RHI3P8KV2	MF-BETA-RHI3P10KV2
Input DC (PV side)		
Recommended max. PV power	12800W	16000W
Max. input voltage	1000V	
Rated voltage	600V	
Start-up voltage	160V	
MPPT voltage range	200-850V	
Full load MPPT voltage range	200-850V	250-850V
Max. input current	16A/16A/16A/16A	
Max. short circuit current	24A/24A/24A/24A	
MPPT number/Max input strings number	4/4	
Battery		
Battery Type	Li-ion	
Battery Voltage range	120 - 600Vdc	
Maximum charging Power	8kW	10kW
Maximum Charge/discharge current	50A	
Communication	CAN/RS485	
Output AC(Grid-side)		
Rated output power	8kW	10kW
Max. apparent output power	8.8kVA	11kVA
Rated grid voltage	3/N/PE, 380V/400V	
The grid voltage range	320-460V	
Rating grid frequency	50 Hz/60 Hz	
AC grid frequency range	45-55 Hz/ 55-65Hz	
Rating grid output current	12.2A/11.5A	15.2A/14.4A
Max. output current	13.4A/12.7A	16.7A/15.8A
Power factor	> 0.99 (0.8 leading to 0.8 lagging)	
THDi	< 3%	

8. Specifications

Technical Data	MF-BETA-RHI3P8KV2	MF-BETA-RHI3P10KV2
Input AC(Grid-side)		
Max. input power	12kW	15kW
Rated input current	18.2A	22.8A
Rated input voltage	3/N/PE, 380V/400V	
Rated input frequency	50 Hz/60 Hz	
Output AC(Back-up)		
Rated output power	8kW	10kW
Peak apparent output power	12.8kVA, 60 sec	16kVA, 60 sec
Back-up switch time	< 10ms	
Rated output voltage	3/N/PE, 380V/400V	
Rated frequency	50 Hz/60 Hz	
Rated output current	12.2A/11.5A	15.2A/14.4A
THDv(@linear load)	<2%	
Efficiency		
PV Max. efficiency	98.03%	98.04%
EU efficiency	97.41%	97.51%
BAT charged by PV Max. efficiency	98.22%	98.31%
BAT charged/discharged to AC Max. efficiency	97.50%	97.50%
Protection		
Anti-islanding protection	Yes	
AFCI	Yes	
Insulation Resistor detection	Yes	
Residual current monitoring unit	Yes	
Output over current protection	Yes	
Output short protection	Yes	
Output over voltage protection	Yes	
DC switch	Yes	
DC reverse polarity protection	Yes	
PV overvoltage protection	Yes	
Battery reverse protection	Yes	

8. Specifications

Technical Data	MF-BETA-RHI3P8KV2	MF-BETA-RHI3P10KV2
General data		
Dimensions(W/H/D)	600*500*230mm	
Weight	32.6kg	
Topology	Transformerless	
Self consumption (Night)	<25 W	
Operation temperature range	-25°C ~ +60°C	
Relative humidity	0-95%	
Ingress protection	IP66	
Cooling concept	Natural convection	
Max.operation altitude	4000m	
Grid connection standard	G98 or G99, VDE-AR-N 4105 / VDE V 0124, EN 50549-1, VDE 0126 / UTE C 15/VFR:2019, RD 1699/RD 244 / UNE 206006 / UNE 206007-1, CEI 0-21, C10/11, NRS 097-2-1, TOR, EIFS 2018.2, IEC 62116, IEC 61727, IEC 60068, IEC 61683, EN 50530, MEA, PEA	
Safety/EMC standard	IEC 62109-1/-2 ,EN 61000-6-1/-3	
Features		
PV connection	MC4 connector	
Battery connection	Quick Connection plug	
AC connection	Quick Connection plug	
Display	LED + Bluetooth + APP	
Communication	CAN, RS485, Ethernet, Optional:Wi-Fi, Cellular, LAN	
Warranty	5 years (extend to 20 years)	

Master Battery SL

Paseo De Extremadura 39

28935 Móstoles, Madrid, Spain

Tel: +34 918 021 649

Fax: +34 917 750 542

Email: info@masterbattery.es

Web: www.masterbattery.es

Please adhere to the actual products in case of any discrepancies in this user manual.

If you encounter any problem on the inverter, please find out the inverter S/N and contact us, we will try to respond to your question ASAP.